

SERVICE MANUAL

MRI Devices Corporation
3545 SW 47th Avenue
Gainesville, FL 32608

Document TR0093S / TR0091S

Revision D

GE Signa[®] Ovation[™] 0.35T Wrist Array Coil and Baseplate

GE Catalog Part Number:	M20072BC	Wrist Coil and Baseplate
MRIDC Part Number:	800093	Wrist Coil
	800091	Baseplate



DAMAGE IN TRANSPORTATION

All packages should be closely examined at time of delivery. If damage is apparent, have notation "**damage in shipment**" written on **all** copies of the freight or express bill **before** delivery is accepted or "signed for" by a General Electric representative or a hospital receiving agent. Whether noted or concealed, damage **MUST** be reported to the carrier **immediately** upon discovery, or in any event, within **14** days after receipt, and the contents and containers held for inspection by the carrier. A transportation company will not pay a claim for damage if an inspection is not requested within this **14** day period.

Immediately complete a "Damage Loss Claim Form", available via MS Exchange Mail, after the damage is found.

MS Exchange Path:

Outlook/Public Folder/All Public Folders/Medical Systems!/Global Initiatives/Information Management/Forms/Common Forms/DAMAGE LOSS CLAIM FORM.

Send the completed form to the email address listed in the form.

For more information about the Transportation Claim Procedure, access the GE Medical Systems Intranet and enter the following URL address (case sensitive):

<ftp://3.87.40.2/globepro/qualsys/Docs/190016MF.PDF>

Rev. 11/15/2000

Language Policy For Service Documentation (Dir. 2128126)

WARNING

- THIS SERVICE MANUAL IS AVAILABLE IN ENGLISH ONLY.
- IF A CUSTOMER'S SERVICE PROVIDER REQUIRES A LANGUAGE OTHER THAN ENGLISH, IT IS THE CUSTOMER'S RESPONSIBILITY TO PROVIDE TRANSLATION SERVICES.
- DO NOT ATTEMPT TO SERVICE THE EQUIPMENT UNLESS THIS SERVICE MANUAL HAS BEEN CONSULTED AND IS UNDERSTOOD.
- FAILURE TO HEED THIS WARNING MAY RESULT IN INJURY TO THE SERVICE PROVIDER, OPERATOR OR PATIENT FROM ELECTRIC SHOCK, MECHANICAL OR OTHER HAZARDS.

AVERTISSEMENT

- CE MANUEL DE MAINTENANCE N'EST DISPONIBLE QU'EN ANGLAIS.
- SI LE TECHNICIEN DU CLIENT A BESOIN DE CE MANUEL DANS UNE AUTRE LANGUE QUE L'ANGLAIS, C'EST AU CLIENT QU'IL INCOMBE DE LE FAIRE TRADUIRE.
- NE PAS TENTER D'INTERVENTION SUR LES ÉQUIPEMENTS TANT QUE LE MANUEL SERVICE N'A PAS ÉTÉ CONSULTÉ ET COMPRIS.
- LE NON-RESPECT DE CET AVERTISSEMENT PEUT ENTRAÎNER CHEZ LE TECHNICIEN, L'OPÉRATEUR OU LE PATIENT DES BLESSURES DUES À DES DANGERS ÉLECTRIQUES, MÉCANIQUES OU AUTRES.

WARNUNG

- DIESES KUNDENDIENST-HANDBUCH EXISTIERT NUR IN ENGLISCHER SPRACHE.
- FALLS EIN FREMDER KUNDENDIENST EINE ANDERE SPRACHE BENÖTIGT, IST ES AUFGABE DES KUNDEN FÜR EINE ENTSPRECHENDE ÜBERSETZUNG ZU SORGEN.
- VERSUCHEN SIE NICHT, DAS GERÄT ZU REPARIEREN, BEVOR DIESES KUNDENDIENST-HANDBUCH NICHT ZU RATE GEZOGEN UND VERSTANDEN WURDE.
- WIRD DIESE WARNUNG NICHT BEACHTET, SO KANN ES ZU VERLETZUNGEN DES KUNDENDIENSTTECHNIKERS, DES BEDIENERS ODER DES PATIENTEN DURCH ELEKTRISCHE SCHLÄGE, MECHANISCHE ODER SONSTIGE GEFAHREN KOMMEN.

AVISO

- ESTE MANUAL DE SERVICIO SÓLO EXISTE EN INGLÉS
- SI ALGÚN PROVEEDOR DE SERVICIOS AJENO A GEMS SOLICITA UN IDIOMA QUE NO SEA EL INGLÉS, ES RESPONSABILIDAD DEL CLIENTE OFRECER UN SERVICIO DE TRADUCCIÓN.
- NO SE DEBERÁ DAR SERVICIO TÉCNICO AL EQUIPO, SIN HABER CONSULTADO Y COMPRENDIDO ESTE MANUAL DE SERVICIO.

- LA NO OBSERVANCIA DEL PRESENTE AVISO PUEDE DAR LUGAR A QUE EL PROVEEDOR DE SERVICIOS, EL OPERADOR O EL PACIENTE SUFRAN LESIONES PROVOCADAS POR CAUSAS ELÉCTRICAS, MECÁNICAS O DE OTRA NATURALEZA.

ATENÇÃO

- ESTE MANUAL DE ASSISTÊNCIA TÉCNICA SÓ SE ENCONTRA DISPONÍVEL EM INGLÊS.
- SE QUALQUER OUTRO SERVIÇO DE ASSISTÊNCIA TÉCNICA, QUE NÃO A GEMS, SOLICITAR ESTES MANUAIS NOUTRO IDIOMA, É DA RESPONSABILIDADE DO CLIENTE FORNECER OS SERVIÇOS DE TRADUÇÃO.
- NÃO TENHA TENTADO REPARAR O EQUIPAMENTO SEM TER CONSULTADO E COMPREENDIDO ESTE MANUAL DE ASSISTÊNCIA TÉCNICA.
- O NÃO CUMPRIMENTO DESTA AVISO PODE POR EM PERIGO A SEGURANÇA DO TÉCNICO, OPERADOR OU PACIENTE DEVIDO A CHOQUES ELÉTRICOS, MECÂNICOS OU OUTROS.

AVVERTENZA

- IL PRESENTE MANUALE DI MANUTENZIONE È DISPONIBILE SOLTANTO IN INGLESE.
- SE UN ADDETTO ALLA MANUTENZIONE ESTERNO ALLA GEMS RICHIEDE IL MANUALE IN UNA LINGUA DIVERSA, IL CLIENTE È TENUTO A PROVVEDERE DIRETTAMENTE ALLA TRADUZIONE.
- SI PROCEDA ALLA MANUTENZIONE DELL'APPARECCHIATURA SOLO DOPO AVER CONSULTATO IL PRESENTE MANUALE ED AVERNE COMPRESO IL CONTENUTO.
- NON TENERE CONTO DELLA PRESENTE AVVERTENZA POTREBBE FAR COMPIERE OPERAZIONI DA CUI DERIVINO LESIONI ALL'ADDETTO ALLA MANUTENZIONE, ALL'UTILIZZATORE ED AL PAZIENTE PER FOLGORAZIONE ELETTRICA, PER URTI MECCANICI OD ALTRI RISCHI.

警告

- このサービスマニュアルは英語版しかありません。
- GEMS以外でサービスを担当される業者が英語以外の言語を要求される場合、翻訳作業はその業者の責任で行うものとさせていただきます。
- このサービスマニュアルを熟読し、理解せずに装置のサービスを行わないでください。
- この警告に従わない場合、サービスを担当される方、操作員あるいは患者さんが、感電や機械的又はその他の危険により負傷する可能性があります。

注意:

- 本维修手册仅存有英文本。
- 非 GEMS 公司的维修员要求非英文本的维修手册时，客户需自行负责翻译。
- 未详细阅读和完全了解本手册之前，不得进行维修。
- 忽略本注意事项会对维修员，操作员或病人造成触电，机械伤害或其他伤害。

TABLE OF CONTENTS

Damage in Transportation	2
Section 1 - Introduction.....	6
1-1 Product Identification and Shipping List.....	6
1-2 Compatibility	6
1-3 Related Documentation	7
1-4 Environmental Requirements.....	7
1-5 Theory of Operation.....	7
Section 2 - Setup and Calibration	9
2-1 Coil Installation.....	9
2-1-1 Special Install Notes	9
2-1-2 Configuration	9
2-2 Installation Functional Checks	9
2-3 Periodic Quality Assurance Check	9
2-4 Coil Tuning.....	10
2-4-1 Required Equipment	10
2-4-2 Tuning Procedure	10
Section 3 - Functional Checks.....	16
3-1 Scanner Verification	16
3-2 Coil Imaging Performance Verification.....	16
3-2-1 Tools Required	16
3-2-2 Scan Setup.....	16
3-2-3 Phantom Scan	19
3-2-4 Create Subtraction Images	20
3-2-5 SNR Image Analysis.....	21
3-3 External Cable Check	23
3-4 PIN Diodes Check	25
3-5 Mechanical Hardware Check.....	26
3-6 Troubleshooting Tips	27
Section 4 - Maintenance	28
4-1 Coil Care.....	28
4-2 Special Care Requirements	28
Section 5 - Replacement.....	29
5-1 Disassembly of Coil	29
5-2 External Cable Replacement.....	29
5-3 Mechanical Hardware Replacement	29
SECTION 6 - Renewal Parts.....	30
6-1 Field Replaceable Units.....	30
6-2 Other Replaceable Accessories	30
SECTION 7 - Appendix	31
7-1 SNR Data Sheet	31
7-2 Schematic	31
7-3 Coil Configuration.....	32
Revision History	33

SECTION 1 - INTRODUCTION

1-1 Product Identification and Shipping List

This is a service manual for the GE Signa[®] Ovation[™] 0.35T Wrist Array Coil and Baseplate

Figure 1-1-1

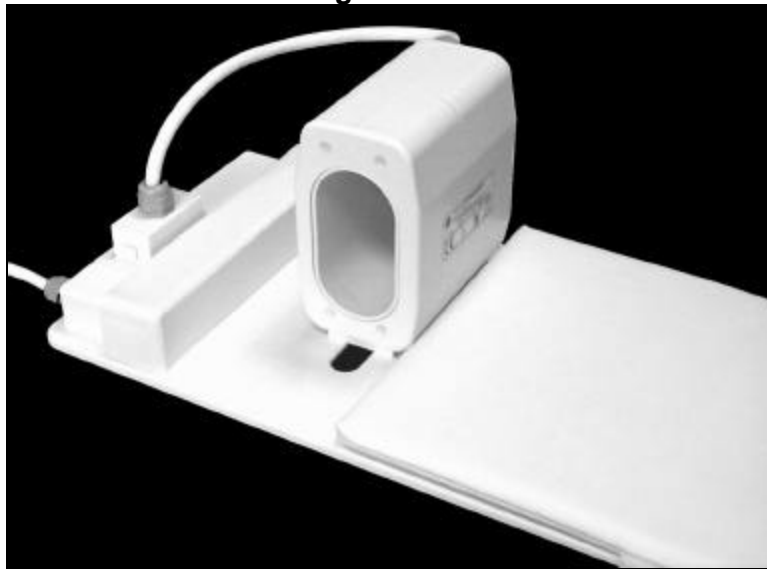

SHIPPING LIST – TABLE 1-1-1

Description	GE Part #	MRIDC Part #	Qty
Wrist Array Coil with Cable (attached to coil)	2283061	101133	1
Base Plate Assembly with Cable	2283062	101137	1
4 Way BNC Adapter	2275809	101139	1
Phantom	2261600	101147	1
Phantom Positioner	2263557	101102	1
Wrist Pad	2261599	100870	1
Thick Pad	2284549	101401	4
Thin Pad	2282859	101400	2
Baseplate Pad	2261604	100936	1
Preamplifier Cover Pad	2263559	100837	1
Operator's Manual	2282849	500045	1
Service Manual	2284552	TR0093S	1

1-2 Compatibility

This coil is compatible with the GE Signa[®] Ovation[™] 0.35T System

1-3 Related Documentation

0.35T Wrist Array Coil Operator Manual, 2282849

GE MR Service Methods CD, 2283084

1-4 Environmental Requirements

Storage Requirements

The coil should be stored in the Scanner Room. The coil dimensions and weight represent the coil and baseplate combined. The phantom dimensions represent the phantom and phantom holder combined. The phantom weight represents the phantom, filled with fluid, and the phantom holder combined.

Dimensions

Coil Dimension:	762 mm x 305 mm x 244 mm	(30.48 in x 12.2 in x 9.76 in)
Phantom Diameter:	153 mm x 92 mm x 65 mm	(6.12 in x 3.68 in x 2.6 in)

Weight

Coil Weight:	7.8 kg	(17.16 lb)
Phantom Weight:	1.4 kg	(3.08 lb)

1-5 Theory of Operation

Refer to the Block Diagram [Figure 1-5-1] on the following page.

The Phased Array Wrist Coils consist of one coil with 3 elements: a Solenoid, a Counter-Rotating-Coil (CRC) and a Helmholtz Pair (HP). Each element contains items 1, 2, and 3.

Item 1 is a tuning and decoupling circuit, which uses passive decoupling via back to back fast acting diodes which are enabled by the RF pulses. When the diodes short, the network creates a high impedance block to eliminate decoupling artifact and interaction with the excitation field.

Item 2 is a tuning, matching, and decoupling circuit which not only tunes the coil to the system resonant frequency and matches the coil to 50 ohms when loaded, it also provides decoupling when the DC bias on the T/R driver pins is positive.

Item 3 provides the proper phase shift between the preamplifier and item 2 to create the phased array decoupling required during receive.

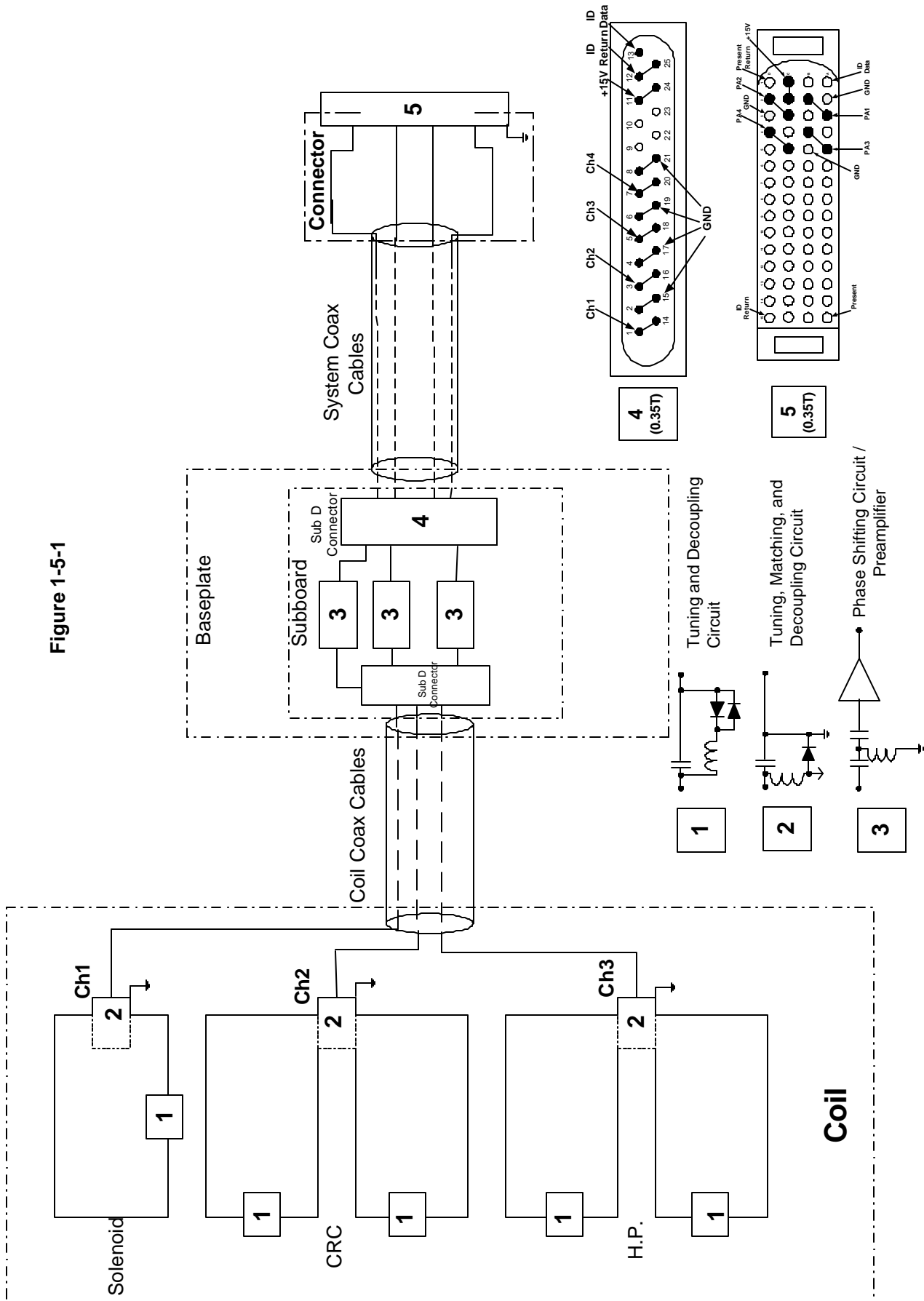

SECTION 2 - SETUP AND CALIBRATION

2-1 Coil Installation

2-1-1 Special Install Notes

None

2-1-2 Configuration

The system will automatically recognize the coil using the Coil ID feature. No configuration should be required. For reference, the configuration information, Table 7-3-1, is included in the Appendix. Check the system coil configuration file and verify that it is the same as the coil configuration table in the latest manual.

2-2 Installation Functional Checks

1. Plug the coil into the patient table and verify that the coil indicator light, on the side of the port, turns green. A green light indicates the system identifies the coil.
2. Select New Patient scan and verify the system software recognizes the coil by displaying the appropriate name (a picture of the coil should also appear).
3. Perform system level Signal to Noise Check. Refer to Service Methods CD; System Level Procedures; Functional Checks; Signal to Noise Check.
4. Perform Section 3 - Coil Imaging Performance Verification.

2-3 Periodic Quality Assurance Check

On a periodic basis, such as during planned maintenance, perform the quality assurance checks as outlined below to ensure the coil is operating properly.

1. Check external cable for cracks or cuts.
2. Perform Section 3 - Coil Imaging Performance Verification and record data values in Data Sheet.

2-4 Coil Tuning

2-4-1 Required Equipment

- Vector Impedance Meter (VIM).
- Philips screwdriver (cross-tip screwdriver).
- Small flat screwdriver.
- BNC adapter (provided with coil).
- 2 BNC shorts (provided with coil).
- Coil tuning cable 1: 2284525 (provided with system)
- Coil tuning cable 1-2: 2288849 (provided with system)

Figure 2-4-1-1

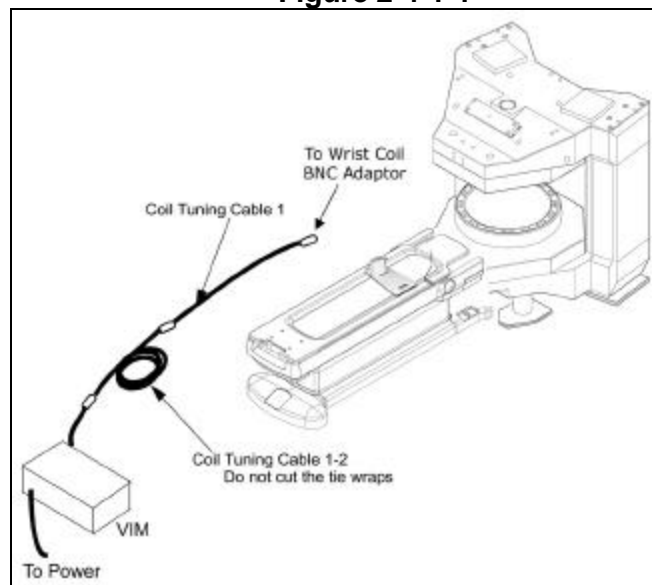

2-4-2 Tuning Procedure

1. Check the Center Frequency of the Magnet (f_0).
2. Turn VIM power ON (wait 10 min. until VIM stabilizes).
3. Attach the wrist PA to the setting position of the base plate.
(Towards the center of the base plate).
Do not connect the cable to the baseplate connector. [Figure 2-4-2-1]
4. Move the cradle laterally to right direction. [Figure 2-4-2-2]

Figure 2-4-2-1

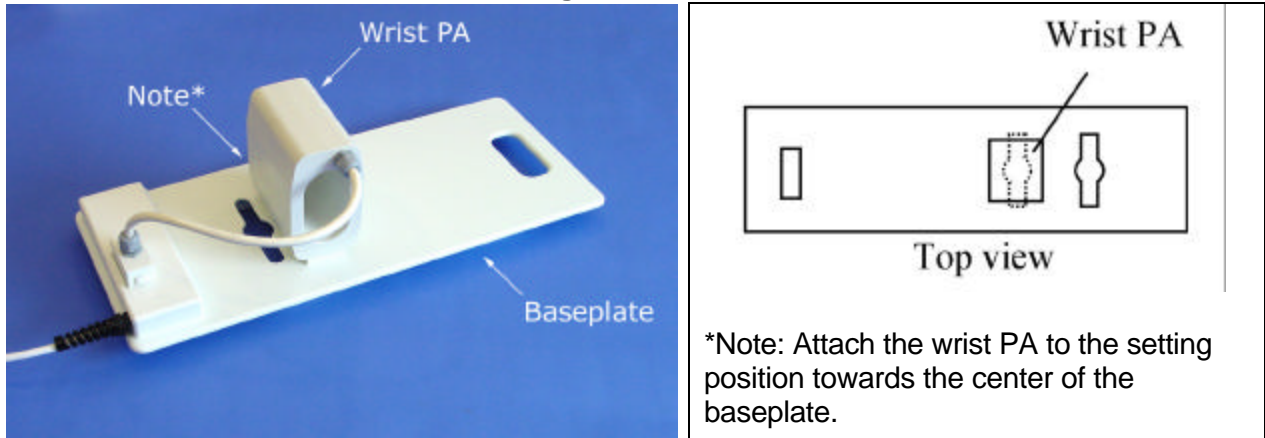

5. Set the Wrist PA with baseplate on the Cradle. [Figure 2-4-2-2]

Figure 2-4-2-2a

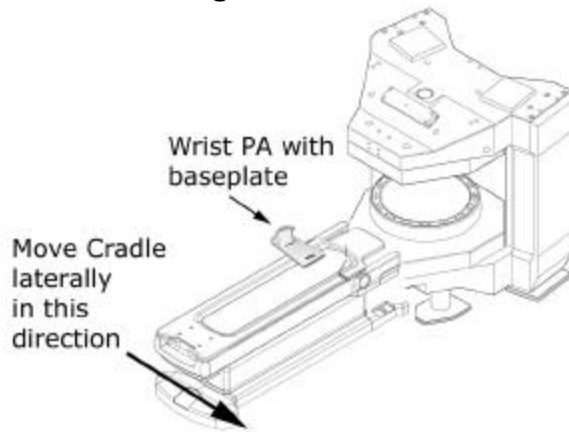
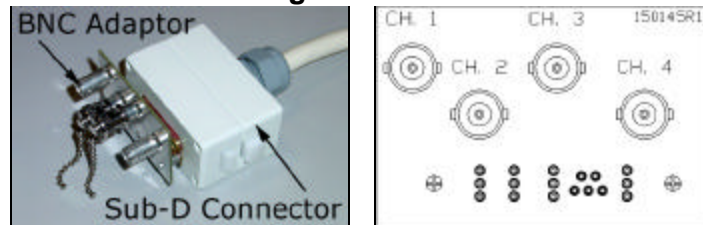

Figure 2-4-2-2b



6. Position the wrist phantom in the coil. [Figure 2-4-2-2b]
7. Connect the provided BNC adaptor to the coil sub-D connector. [Figure 2-4-2-3]

Figure 2-4-2-3



8. Then connect CH. 1 (solenoid) of the adapter to the VIM.
Connect the standard BNC shorts to CH. 2 and CH. 3 of the adapter. [Figure 2-4-2-4]

Figure 2-4-2-4

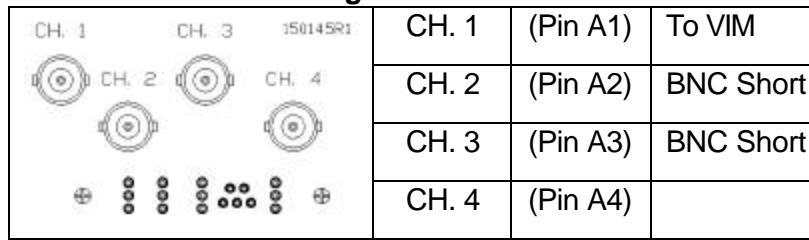

9. Align the Wrist coil to the alignment light and advance it to Magnet center. [Figure 2-4-2-5]

Figure 2-4-2-5



Measure the resonance frequency by using the following procedure: [Figure 2-4-2-6]

- a. Adjust the phase as near as possible to 0° .

Note - Measuring mode on VIM: **High Speed ON.**

- b. Record the corresponding frequency (f_c).
- c. Record the difference between the measured frequency and that of the magnet.

Figure 2-4-2-6

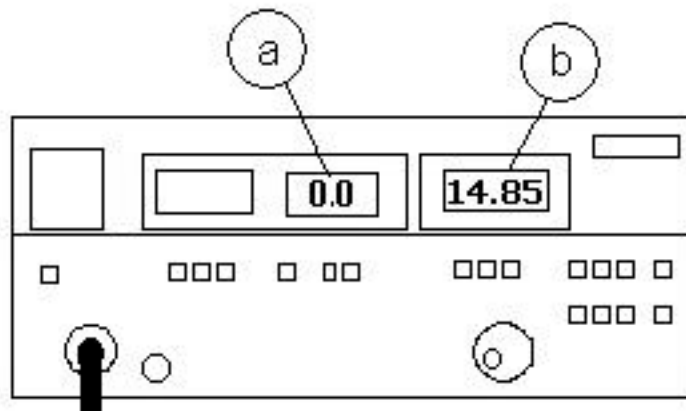

10. Repeat step 9 for CH. 2 (CRC) of the BNC adapter.
This time connect the two BNC shorts to CH. 1 and CH. 3. [Figure 2-4-2-7]

Figure 2-4-2-7

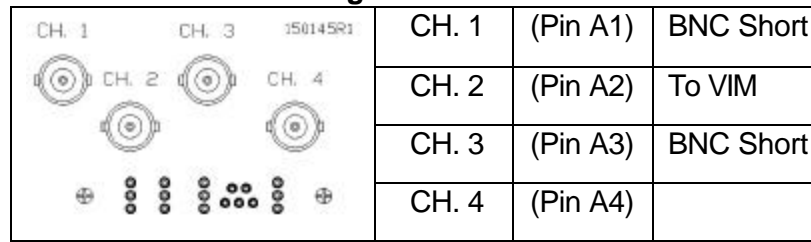

11. Check that the measured frequency for A1(solenoid) is within the specification or not.
 12. Specification: $f_c = f_0$ (magnet center frequency) $\pm 0.01\text{MHz}$
 If it is within the specification, skip step 19 to step 20.
 13. Check that the measured frequency for A2(CRC) is within the specification or not.
Specification: $f_c = f_0$ (magnet center frequency) $\pm 0.01\text{MHz}$
 If it is within the specification, skip step 21 to step 22.

If measured frequencies of A1(solenoid) and A2(CRC) satisfy the specification, it is not necessary to perform the following procedure. Finish now.

14. Move the cradle out from the Magnet.
 15. Remove the coil from the baseplate.
 16. Set the Wrist PA up-side down.
 Remove the 4 screws attaching the mounting bracket to the coil and remove the mounting bracket.
 [Figure 2-4-2-8]

Figure 2-4-2-8

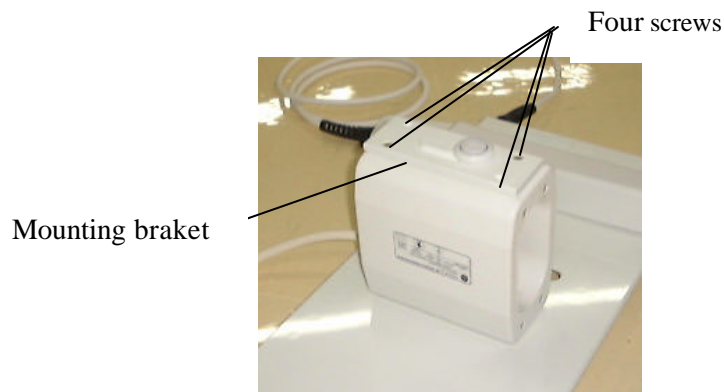

17. Move the coil to the Magnet center.

18. Reconnect CH. 1 to VIM (shorts on CH. 2 and CH. 3). [Figure 2-4-2-9]

Figure 2-4-2-9

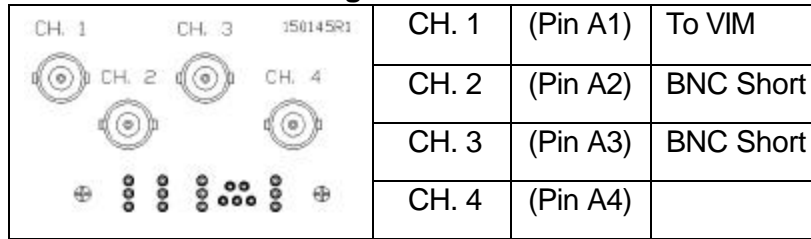

19. Adjust the center frequency by using the following procedure: [Figure 2-4-2-10]
 a. Set the frequency of VIM to f_0 (magnet center frequency).
 b. Using small flat screwdriver, rotate the center trimmer capacitor (marked as A1-SOL) to target phase to **0**.

Figure 2-4-2-10

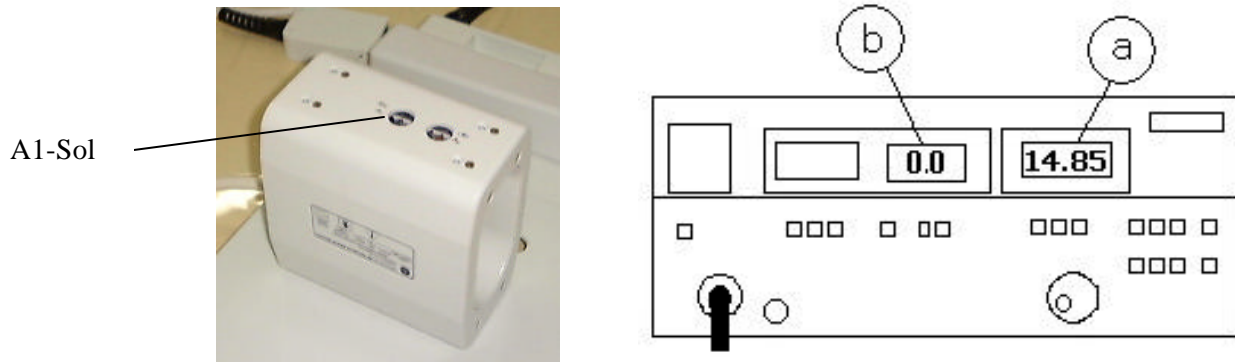

20. Connect CH. 2 to the VIM (shorts on CH. 1 and CH. 3). [Figure 2-4-2-11]

Figure 2-4-2-11

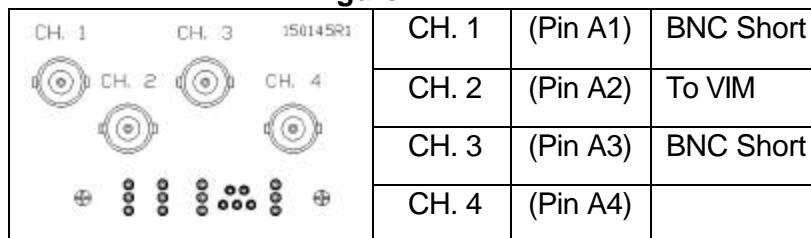

- 21. Adjust the center frequency by using the following procedure: [Figure 2-4-2-12]
 - a. Set the frequency of VIM to f_0 (magnet center frequency)
 - b. Using small flat screwdriver, rotate the lateral trimmer capacitor (marked as A2-CRC) to target phase to **0**.

Figure 2-4-2-12

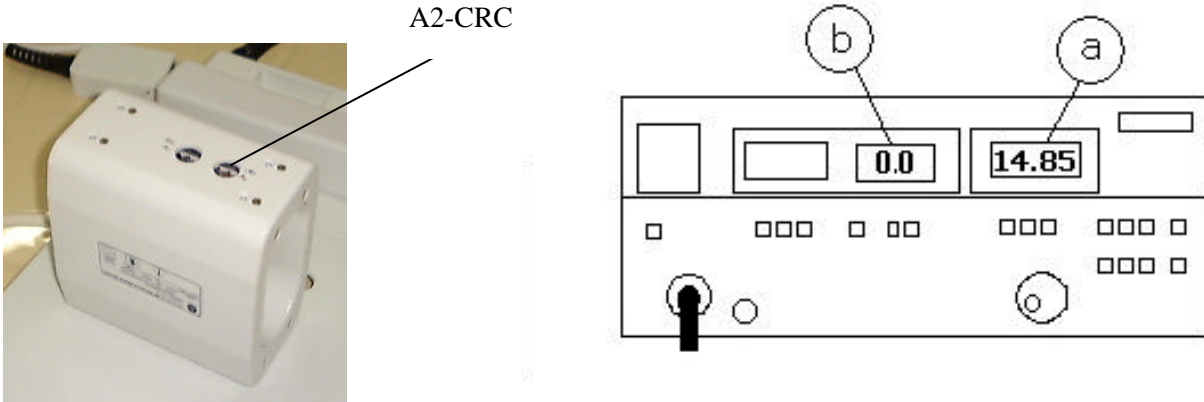

- 22. Reassemble the mounting bracket and the coil to the baseplate. Then repeat the frequency measured in the Magnet to verify that the coil is tuned to the magnet center Frequency, within $\pm 0.01\text{MHz}$.

SECTION 3 - FUNCTIONAL CHECKS

3-1 Scanner Verification

Perform system level Signal to Noise Check. Refer to Service Methods CD; System Level Procedures; Functional Checks; Signal to Noise Check.

3-2 Coil Imaging Performance Verification

3-2-1 Tools Required

TOOLS REQUIRED – TABLE 3-2-1-1

Description	GE Part #	MRIDC Part #	Qty
Phantom	2261600	101147	1
Phantom Positioner	2263557	101102	1

3-2-2 Scan Setup

1. Select [New Pt] to set a new landmark. [Figure 3-2-2-1]

Figure 3-2-2-1

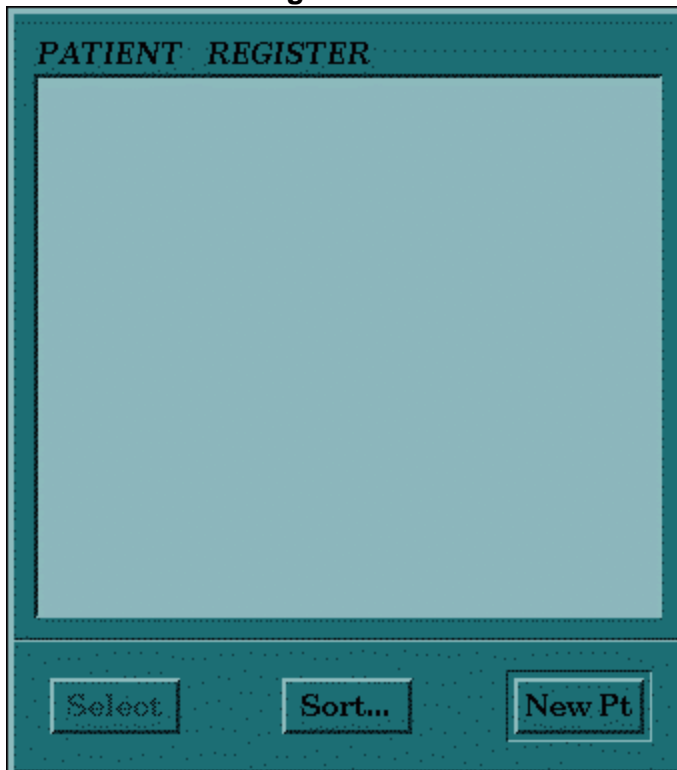

2. Remove any other surface coils (if present) from the cradle. Place the baseplate near the top of the cradle, and set the cable on the left side. Set the coil on the right side hole (near center)(See Figures 3-2-2-2 & 3-2-2-3).

Figure 3-2-2-2



Figure 3-2-2-3

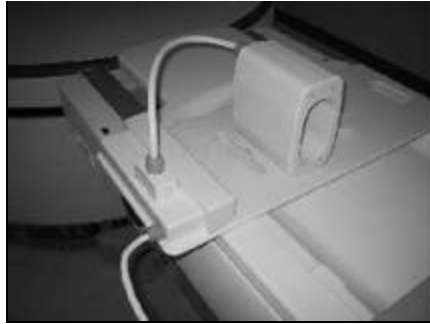

Baseplate and Coil Orientation

- Place the wrist array phantom on the phantom holder and place them into the coil from the near side (See Figures 3-2-2-4 and 3-2-2-5). Connect the coil connector to the coil port.

Figure 3-2-2-4



Phantom on Holder

Figure 3-2-2-5



Slide Phantom into Coil

- At the magnet, press the "Alignment Light" button to turn on the light. Move the cradle to align the coil to the alignment lights as shown in Figures 3-2-2-6 and 3-2-2-7. Use the lateral handle to set "120" (the phantom near the center)(The first lot table may be moved only "90", then set "90." If you use lateral "90," then the phantom is located left side on Image.) Press the "Landmark" button to landmark the alignment.

Figure 3-2-2-6



Alignment - Wrist Coil with Phantom

Figure 3-2-2-7

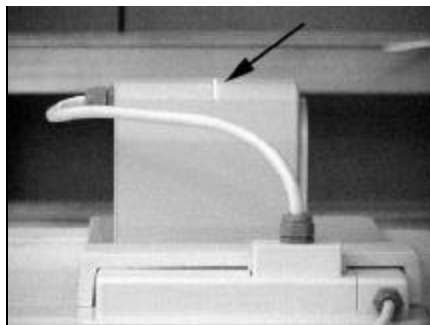

- Move the coil to scan position by pushing the "Move to Scan" button, ensuring cable does not get snagged.
- Enter "geservice" for [Patient ID]. [Figure 3-2-2-8]
- Enter "QA Scan" for [Patient name]. [Figure 3-2-2-8]

Figure 3-2-2-8

PATIENT INFORMATION

Accession Number

Patient ID

Patient Name

Birth Date Age

Sex Weight Lb Kg

Rad Refer

Operator Status

Exam Description

History

8. Enter "111" lbs for [Weight]. [Figure 3-2-2-8]
9. Select [Patient Position].
10. At the console, verify the Coil has been properly identified by the system: correct picture on the screen and correct name in Coil field. If the system does not recognize the coil, refer to Section 2, Setup and Calibration.
11. Enter the following parameters: [refer to Table 3-2-2-1]

SNR PROTOCOL SHEET - TABLE 3-2-2-1

Patient/Exam Information			
Patient ID	geservice		
Patient Name	QA Scan		
Patient Weight	111 lbs (50kg)		
Landmark	Nasion		
Table Entry	Center		
Patient Position			
Patient Position	Supine		
Patient Entry	Head first		
Coil	Wrist		
Series Description	<i>leave blank</i>		
Imaging Parameters			
Plane	Coronal		
Mode	2D		
Pulse Seq	Spin Echo		
Imaging Options	None		
PSD Name	<i>leave blank</i>		
Protocol	<i>leave blank</i>		
Scan Timing			
# of Echoes	1		
TE	25.0		
TR	500		
Bandwidth	10.42		
Additional Parameters			
<i>no entries required in this area</i>			
Acquisition Timing			
Freq	256		
Phase	256		
NEX	1.0		
Phase FOV	1.0		
Freq DIR	S/I		
Auto Center Freq	Peak		
Auto Shim	On		
Contrast	Off		
Scanning Range			
FOV	20		
Slice Thickness	5		
Spacing	0		
	A/P	S/I center	R/L center
start	P60	0	0
End	P60		
# Slices	1		

12. Select [Save Series].

3-2-3 Phantom Scan

1. Choose the saved series and select [Prepare to scan].
2. Move the mouse pointer to [Research Operations] then click the right mouse button.

3. Select [Display CVs].

Figure 3-2-3-1

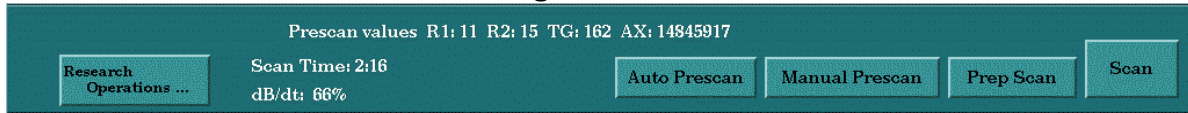

4. Enter “saveinter” for CV name, set the current value to 1. Press the enter key to save the changes made in the “saveinter” window. Press [Accept] to close the window.
5. Select [Auto Prescan].
6. Select [Scan].
7. Wait for scan to finish before proceeding.
8. After first scan, select [Scan] again.

3-2-4 Create Subtraction Images

1. Select [Display Icon] to display the Browser.
2. Select the exam named “QA Scan”
3. After the phantom scan, select [Add / Sub] from browser.

Figure 3-2-4-1

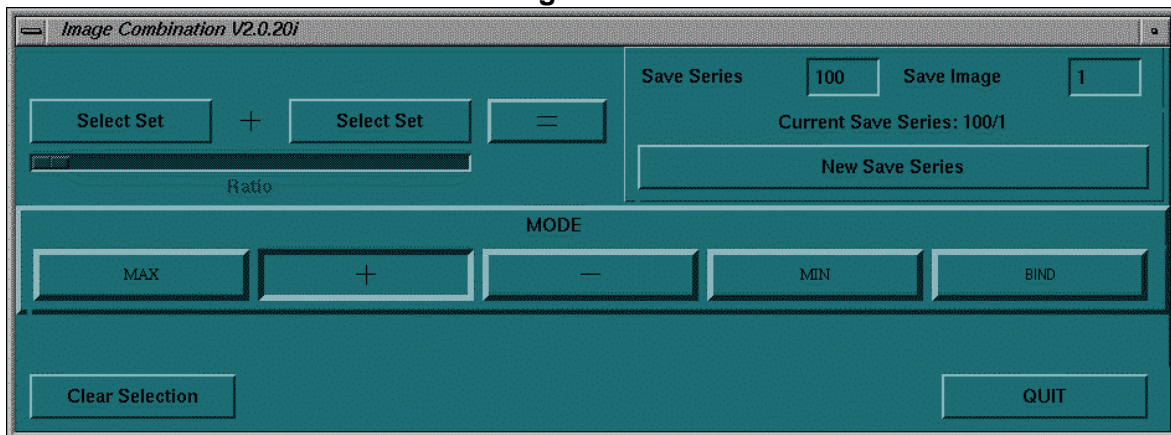

4. Select MODE [-] and Check [Accept Negative Pixels].
5. Select image #1 from browser and then Select [Select Set](left button on the Image Combination window).
6. Select image #6 from browser and then Select [Select Set] (right button on the Image Combination window).
7. Select [=].

- Also create Subtraction Images using, (image #2 – image #7) ,(image #3 – image #8), and (image #5 – image #10).

Figure 3-2-4-2

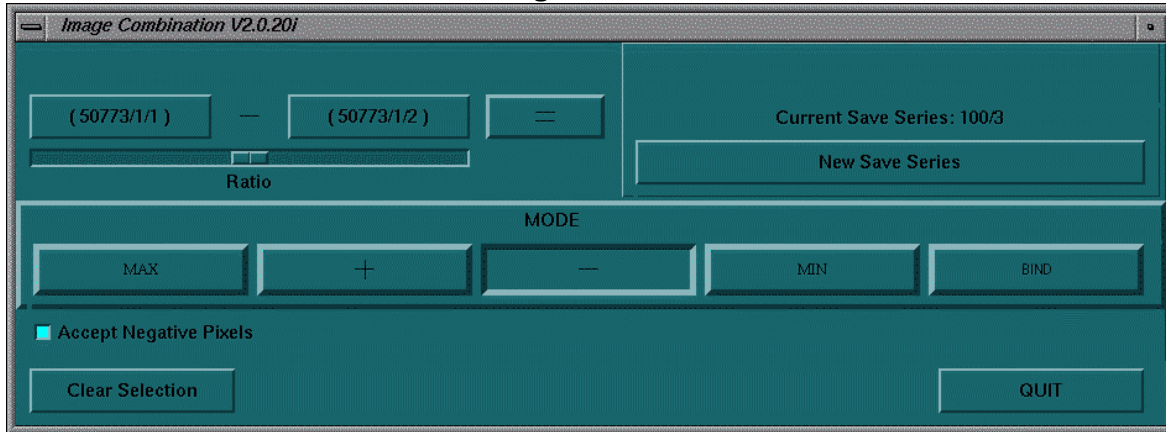

Setting Cursor

- Select [Display Icon] to display the Browser.
- Select the exam named “QA Scan”.
- Select image #1. Select [Mini Viewer]
- Select [Grid] to set cursor.
- Select [Measure] button. Select rectangular cursor and set R/L 4cm x S/I 8cm (Area : 3200mm² +/-100mm²):
- Set cursor to the center of the grid for S/I axis and the center of the phantom for R/L axis.
- Use cursor copy [CTRL]+[C] and paste [CTRL]+[V] to easily set the cursor to each image.

3-2-5 SNR Image Analysis

Signal Measurement

- Measure the mean value of Image #1 and record it in the Appendix SNR worksheet.
- Open Image #6 and measure the mean value with the same size ROI.
- Measure the mean of the other images, #2, #3, #5, #7, #8, and #10.

Noise measurement

- Select subtracted image#1 in the series#100s from browser and select [Mini Viewer].
- Record SD value using with same size ROI on SNR Worksheet on Appendix.

3. Repeat this procedure for image#2, #3, and #4 in series#100s.

SNR Calculation

The SNR is calculated using the following formula:

$$\text{SNR} = ((\text{mean value1})+(\text{mean value2})) / ((\text{SD}) \times 1.414)$$

Spec. >

Element 1 Images - Figure 3-2-5-1

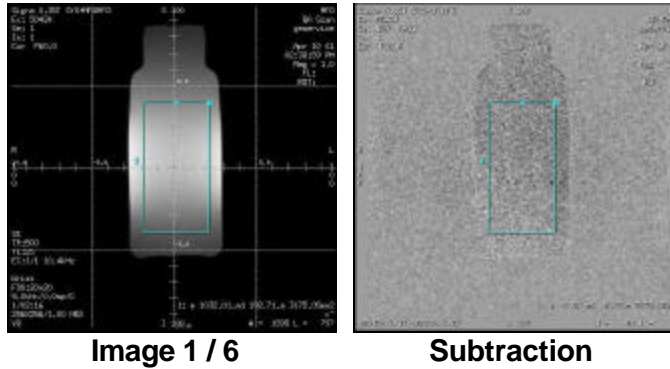

Element 2 Images - Figure 3-2-5-2

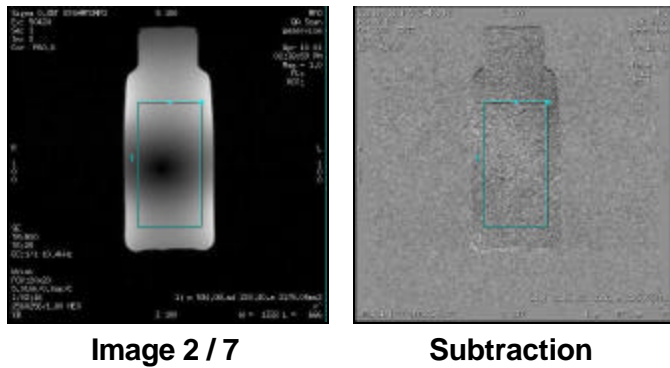

Element 3 Images - Figure 3-2-5-3

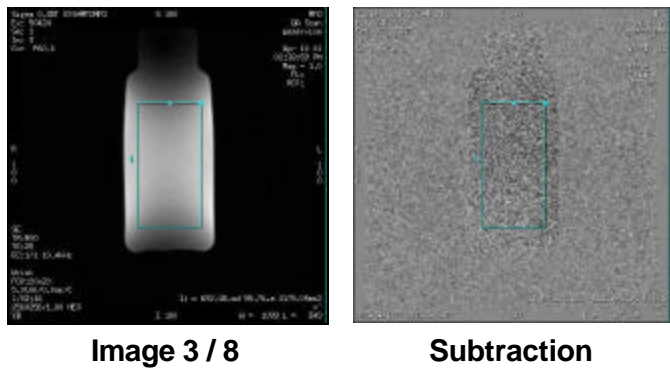

No Signal
Figure 3-2-5-4

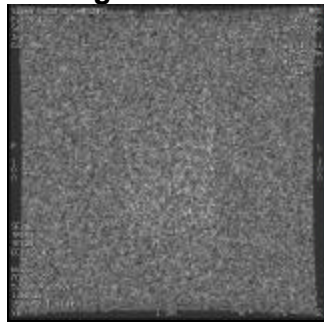

Image 4 / 9

Composite Images - Figure 3-2-5-5

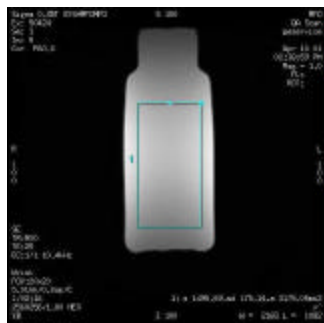
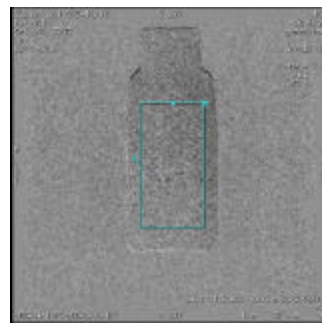

Image 5 / 10



Subtraction

3-3 External Cable Check

Overview: Section 3-3 and 3-4 sequence of events.

- Disconnect the external cable from the system coil port on one end, and from the Wrist Coil baseplate on the other end.
- Perform the External Cable Check, Section 3-3.
- Disconnect the Wrist Coil cable connector from the baseplate.
- Perform the Baseplate Segment of the PIN Diodes Check, Section 3-4, with no cables connected to the baseplate.
- Perform the Wrist Coil Segment of the PIN Diodes Check, Section 3-4.

Note: Disconnect the system connector box prior to any cable measurements.

Procedure: Check the external cable using the following procedure.

- Remove four screws (S1 - Figure 3-3-1) from the bottom of the baseplate housing.
- Disconnect the external cable Sub D connector (No. 4 in the block diagram, Figure 1-5-1)
- Using a DMM, measure continuity* through the cable connections as detailed in the Expected Readings Table 3-3-1, and the associated connector Figures 3-3-2 and 3-3-3. (* +15 VDC is a diode measurement)
- If all readings are < 3 ohms, proceed to the Pin Diodes Check, Section 3-4. Also verify that the signal pins are not shorted to GND.

Figure 3-3-1

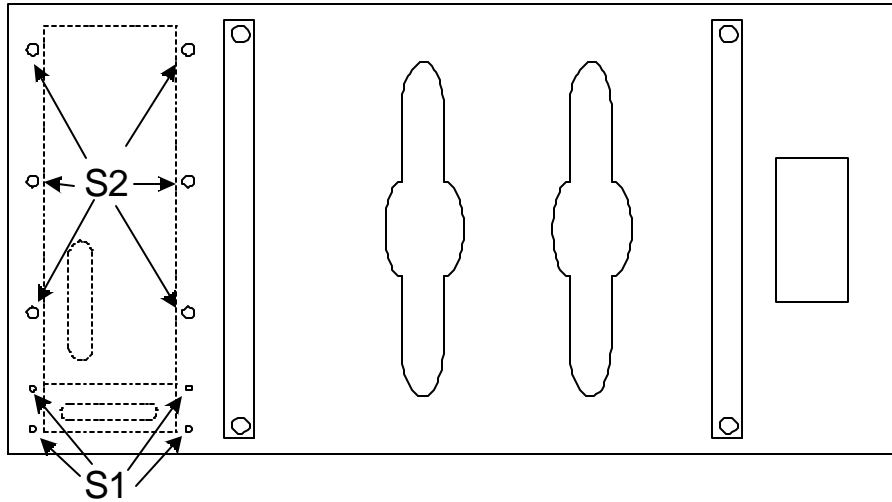

Bottom view of Baseplate

EXTERNAL CABLE EXPECTED READINGS – TABLE 3-3-1

Signal	Baseplate Sub D Connector (27W2) Pin	System Bendix Connector (Bendix60) Pin
Channel 1	1, 14	A3, B2
Channel 2	3, 16	D2, C3
Channel 3	5, 18	A5, B4
Channel 4	7, 20	D4, C5
ID Return	12, 25	D15
ID Data	13	A1
GND	2,4,6,8,15,17,19,21	D3
* +15VDC (One diode drop)	11, 24 (Negative Lead)	C1, C2 (Positive Lead)

Unlike earlier system cables, there is no conductor between the Bendix connector pins A15 & D1 [Present & Present Return]. This system cable uses a circuit design that accurately senses coil presence [or non-presence] with the coil disconnected at the baseplate.

Figure 3-3-2

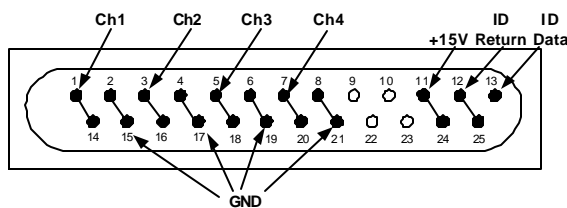

SubD Connector – Baseplate End

Figure 3-3-3

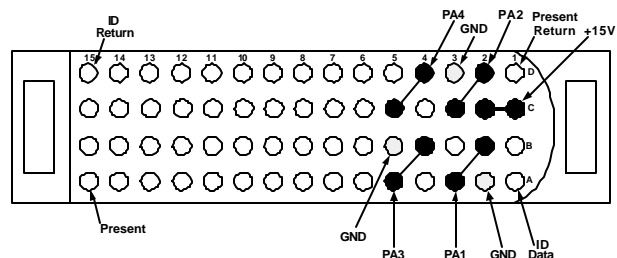

Bendix Connector – System End

3-4 PIN Diodes Check

Baseplate Segment

Disconnect the Wrist Coil cable connector from the baseplate. Using a DMM, measure the following pin combinations in the external cable Sub D connector that is mounted on the baseplate (27W2, No. 4 in the block diagram, Figure 1-5-1). Refer to the Expected Readings Table 3-4-1, and Figure 3-4-1. If all of the readings are correct, proceed to the Wrist Coil Segment. If one or more reading is incorrect, replace the *Base Plate Assembly with Cable*.

PIN DIODE EXPECTED READINGS – TABLE 3-4-1

Positive lead	Negative lead	Reading
Pin 1 (PA1)	GND (Pin 15)	One diode drop
GND (Pin 15)	Pin 1 (PA1)	Open
Pin 3 (PA2)	GND (Pin 17)	One diode drop
GND (Pin 17)	Pin 3 (PA2)	Open
Pin 5 (PA3)	GND (Pin 19)	One diode drop
GND (Pin 19)	Pin 5 (PA3)	Open
Pin 7 (PA4)	GND (Pin 21)	One diode drop
GND (Pin 21)	Pin 7 (PA4)	Open

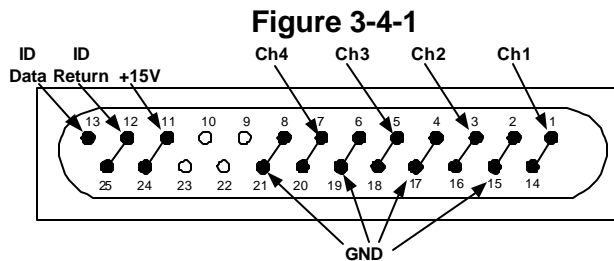

SubD Connector – Baseplate Mount

Wrist Coil Segment

Using a DMM, measure the following pin combinations in the Sub D connector attached to the Wrist Coil cable (27W2, No. 4 in the block diagram, Figure 1-5-1). Refer to the Expected Readings Table 3-4-2, and Figure 3-4-2. If all of the readings are correct, the Wrist Coil segment of the Pin Diodes Check is successfully completed. If one or more reading is incorrect, replace the Wrist Coil.

PIN DIODE EXPECTED READINGS – TABLE 3-4-2

Positive Lead	Negative Lead	Reading
A1 - Center (Ch1)	GND - Shield	One diode drop
GND - Shield	A1 - Center (Ch1)	Open
A2 - Center (Ch2)	GND - Shield	One diode drop
GND - Shield	A2 - Center (Ch2)	Open
A3 - Center (Ch3)	GND - Shield	One diode drop
GND - Shield	A3 - Center (Ch3)	Open

Figure 3-4-2

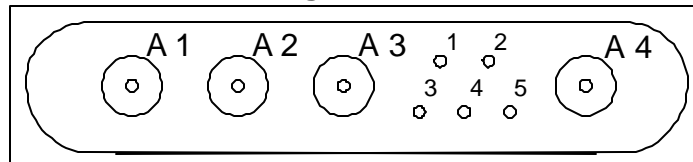

SubD Connector – Wrist Coil Cable

3-5 Mechanical Hardware Check

Not Applicable

3-6 Troubleshooting Tips

If poor image quality or dead channels are present, use the following setup information and compare the resulting images to isolate any defective part(s).

COIL ELEMENT INFORMATION – TABLE 3-6-1

element name	sole-noid	crc	Helm-holz pair	not used	not used	not used	not used	not used	not used
channel number	1	2	3	4	5	6	7	8	n/a
selected channel	See Below			no	no	no	no	no	n/a
mc bias driver #	1	1	2	2	3	3	4	4	n/a
active bias driver	yes	yes	yes	no	no	no	no	no	n/a

selected channel	Yes	Yes	Yes
------------------	-----	-----	-----

Wrist Image Composite ?



selected channel	Yes	No	No
------------------	-----	----	----

Wrist Image Receiver 1 ?

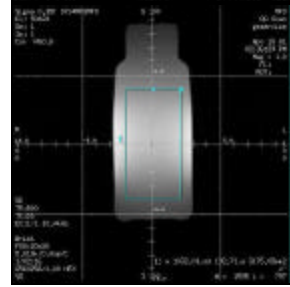

selected channel	No	Yes	No
------------------	----	-----	----

Wrist Image Receiver 2 ?

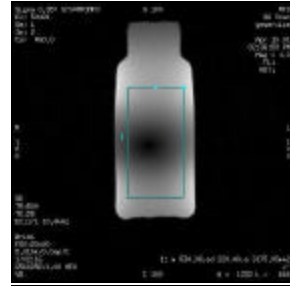

selected channel	No	No	Yes
------------------	----	----	-----

Wrist Image Receiver 3 ?



SECTION 4 - MAINTENANCE

4-1 Coil Care



Detach coil connector from scanner before attempting to clean. Do not reattach after cleaning until coil has dried completely. Having the coil attached to the system during cleaning or when it is wet may result in electrical shock.



Do not spray or pour cleaning solution directly on coil. Do not submerge coil in solution. The coil contains sensitive electronics components that could be damaged by the solution.

The 0.35T Wrist Array Coil, Baseplate and associated pads may be cleaned by wiping with a cloth dampened with a solution of 30% isopropyl alcohol and 70% tap water or a 10% Bleach solution.

4-2 Special Care Requirements

None

SECTION 5 - REPLACEMENT

Simple removals that are clearly obvious are not described here.

Unless otherwise noted, the steps for re-assembly are simply the reverse order of the steps described for disassembly.

5-1 Disassembly of Coil

Not Applicable

5-2 External Cable Replacement

Refer to Figure 1, Section 3-3.

Remove four screws (S1 - Figure 3-3-1) from the bottom of the baseplate housing. Disconnect the external cable Sub D connector and remove the external cable from the baseplate.

5-3 Mechanical Hardware Replacement

Not Applicable

SECTION 6 - RENEWAL PARTS

6-1 Field Replaceable Units

FIELD REPLACEABLE UNITS LIST – TABLE 6-1-1

Description	GE Part #	MRIDC Part #	Qty
0.35T Baseplate Cable	2284550	100850	1
0.35T Baseplate Assy.	2283062	101137	1
0.35T Wrist Array Coil	2283061	101133	1
4 Way BNC Adapter	2275809	101139	1
BNC Shorting Cap	2275810	924025	1
Phantom	2261600	101147	1
Phantom Positioner	2263557	101102	1

6-2 Other Replaceable Accessories

OTHER REPLACEABLE ACCESSORIES LIST – TABLE 6-2-1

Description	GE Part #	MRIDC Part #	Qty
Wrist Pad	2261599	100870	1
Thick Pad	2284549	101401	4
Thin Pad	2282859	101400	2
Baseplate Pad	2262902	100936	1
Preamp Cover Pad	2263559	100837	1

SECTION 7 - APPENDIX

7-1 SNR Data Sheet

Use the table provided below to record the calculated signal to noise ratio (SNR) data obtained from the Functional Checks section.

SNR DATA SHEET – TABLE 7-1-1

Date Tested	Receiver ch.#	Coil Element #	Image #	Signal Mean 1	Signal Mean 2	Noise Image #	Noise SD from Subtraction image	SNR	Spec.
	1	1	1&6			1			
	2	2	2&7			2			
	3	3	3&8			3			
	---	---	4&9						
	composite	composite	5&10			4			
		R1=		R2=					
		TG=		Freq=					

7-2 Schematic

Refer to Block Diagram, Figure 1-5-1, under Section 1-5 Theory of Operation

7-3 Coil Configuration

COIL CONFIGURATION - TABLE 7-3-1

coilCode	MRIDWRIST									
coilName	Wrist									
element name	loop 1	loop 2	saddle	not used	not used	not used	not used	not used	not used	
channel number	1	2	3	4	5	6	7	8	n/a	
selected channel	yes	yes	yes	no	no	no	no	no	n/a	
mc bias driver #	1	1	2	2	3	3	4	4	n/a	
active bias driver	yes	yes	yes	yes	no	no	no	no	n/a	
mcPortEnable	3	bit mask driver 1 = 1, 2 = 2, 3 = 4, 4 = 8								
mcErrorEnable	3	must be same as mcPortEnable								
mcChannelSel	7	see truth table								
mcReconEnable	8	bit mask to cut out receivers: rcvr 0 = 1, 1 = 2, 2 = 4, 3 = 8								
startRec	0	value 0 through 3 must be <= endRec								
endRec	3	value 0 through 3 must be >= startRec								
numRec	4	(endRec - startRec) + 1								
startFastRec	4	always 4								
endFastRec	4	always 4								
numFastRec	0	always 0 except single channel coils with fast receiver present								
ATTN_Q	0	Q channel attenuation. Range 0.0 to 15.5 dB in 0.5 dB steps.								
ATTN_I	0	I channel attenuation. Range 0.0 to 15.5 dB in 0.5 dB steps.								
quadRotation	0	selects quadrature shifter for single channel quadrature coils: 1=+90, 0=-90								
coilType	3	1 = head T/R, 2 = body T/R, 3 = receive only								
extremity	no	must be "yes" or "no", only meaningful if coilType = 1								
cableLoss	1	linear attenuation factor representing loss between RF amp and T/R coil								
coilLoss	1.165	transmit energy lost in coil (joules per standard pulse)								
reconScale	0.12	Gain factor for T/R coils. Rcv only coils multiply this times head coil value.								
multiCoil	yes	must be "yes" or "no"								
linearQuad	1	0 = linear, 1 = quadrature. Applies to transmit coils only.								
xmitAtten	0	equivalent to attenuation added between sys & RF cabs in TG units								
fastTGstartTA	90	subtract this value from 200 to get TG at which fast TG starts								
fastTGstartRG	12	default R1 setting for fast TG								
autoshimRcvr	-1	for T/R phased arrays, tells autoshim which rcvr (0-15) to use, otherwise -1								
headDefaultFreqDir	1	1 means default frequency direction is same as head coil, 0 is not								
quadRcvCoil	0	0 = linear, 1 = quadrature. Only applies to single channel receive & TR coils.								

REVISION HISTORY

Rev	Date	Author	Primary Reason for Change
A	1/8/2000	U. Gotshal	First Issue
B	4/25/2000	L. Hyler	Revise Document Format
C	7/5/2001	L. Hyler	Revise according to YMS Comments
D	7/16/2001	L. Hyler	Further YMS Revisions