

POWER CABINET INSTALLATION

TABLE OF CONTENTS

SECTION	TITLE	PAGE
1	FRONT VIEW WITH MODULE DESIGNATORS	1- 3
2	INPUT VOLTAGE AND CIRCUIT BREAKER DIP SWITCH SETTINGS	1- 3
3	CONNECT POWER CABLES TO PDU MODULE	1- 4
4	ROUTE/CONNECT RUNS 703 AND 706 TO PDU MODULE	1- 5
5	CONNECT RUNS 762, 763, & 764 OUTPUT CRADIANT CABLES	1- 6
6	ROUTE/CONNECT FIBER OPTICS AND RUN 229	1- 7
7	SYSTEM SUPPORT MODULE CABLE CONNECTIONS	1- 8
8	CONNECT RUNS 887, 888 and 935 TO RF INTERFACE (RFI) MODULE	1- 8
9	ATTACH INSITE CABINET MAGNET	1- 9

REV blank

- FRONT VIEW WITH MODULE DESIGNATORS

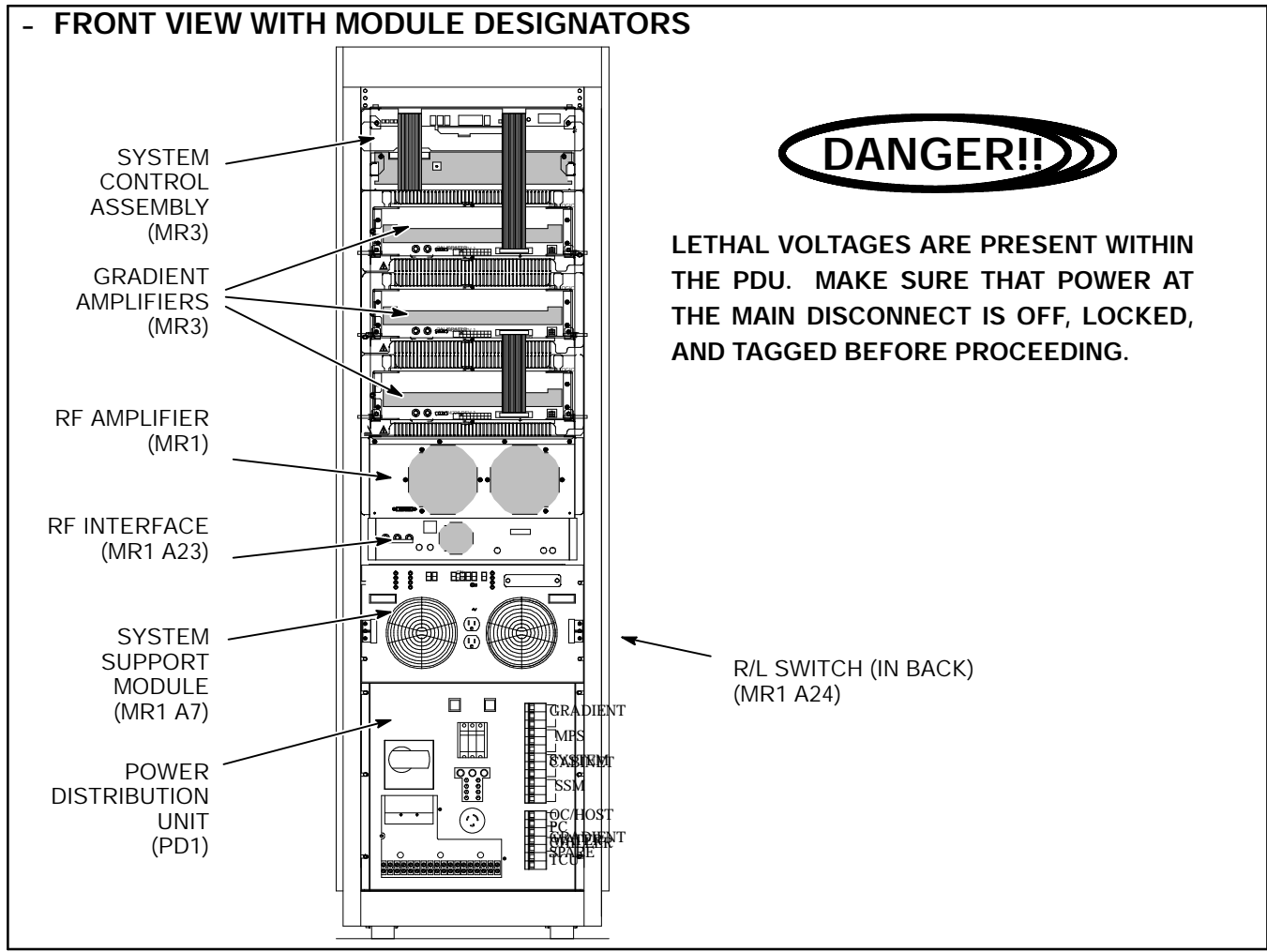

- INPUT VOLTAGE AND CIRCUIT BREAKER DIP SWITCH SETTINGS

Refer to Direction 2266541, *Phoenix PDU Module in 0.7T Power Cabinet*, Section 3, Installation and Operation, for instructions on Input Voltage Selection and Circuit Breaker Dip Switch Settings.

A copy of the manual should be shipped with the cabinet. It can also be found on the MR Service Methods CD- ROM shipped with the system or the MR Service Engineering Web Site.

- CONNECT POWER CABLES TO PDU MODULE

- ① Route/connect power cables to pressure connectors on back of PDU module as shown in Table.
- ② Trim and connect ground wire cables (Runs 037 and 048) to ground bus connectors.

CONNECT TO	RUN	PHASE	DESTINATION
1,2,3		f A, B, C	Gradient Amplifier 3f , Neutral, Ground
16,17,18	030	f A, B, C	System Cabinet 3f , Neutral, Ground
25,31	047	f C,A	Operator Workspace Single f , Neutral, Ground
GROUND	037		System Cabinet Ground Wire
GROUND	048		Operator Workspace Ground Wire
GROUND			Customer Supplied 1/0 Ground Cable

COLOR CODE: for remainder of cables:
 3f = Black, Red, Orange Neutral = Light blue Gnd = Grn/Yel
 Single f = Brown, Black
 Other 3- phase cable Phase Coding: Black = Phase A; Red = Phase B; Orn= Phase C

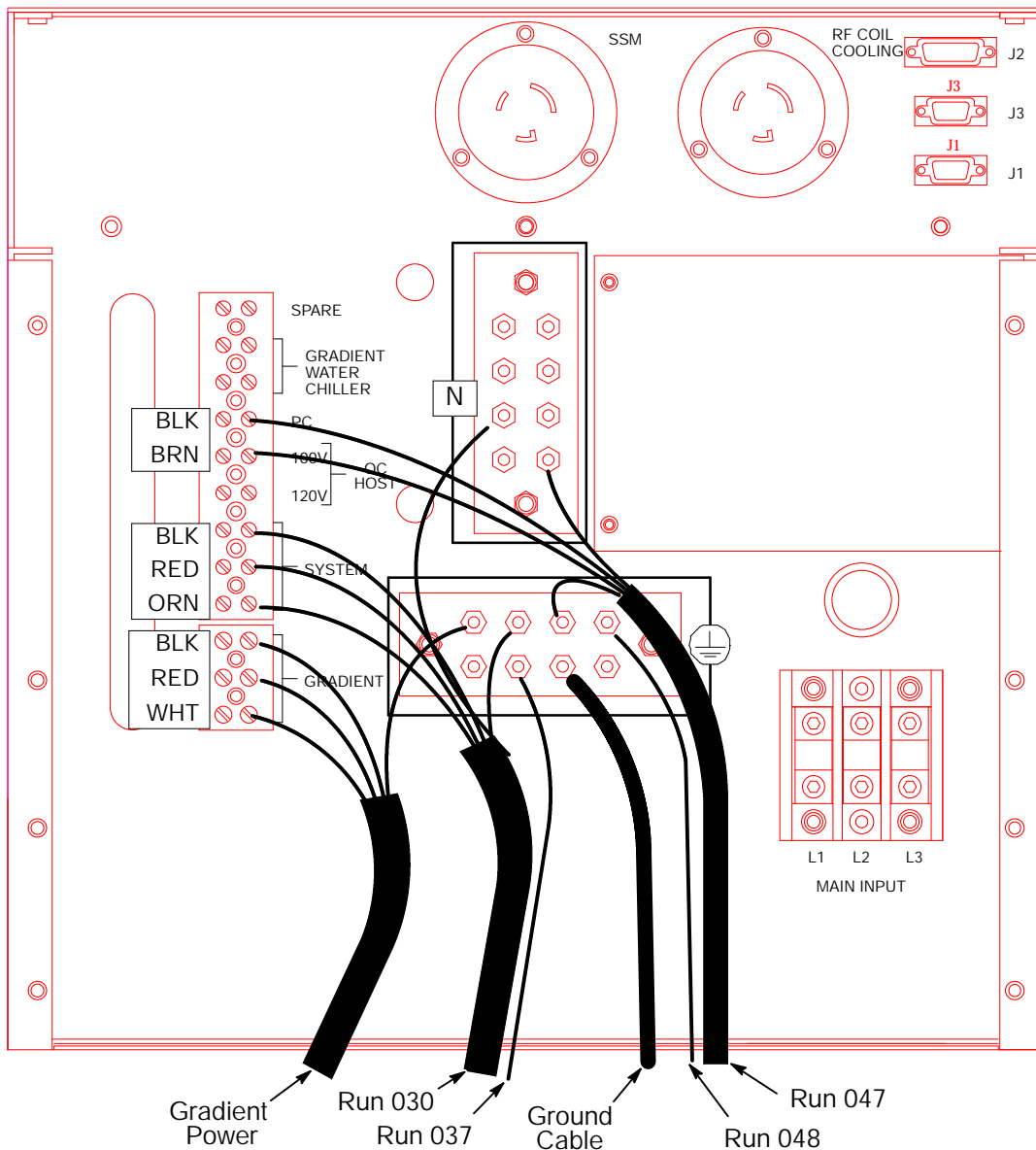

- ROUTE/CONNECT RUNS 703 AND 706 TO PDU MODULE

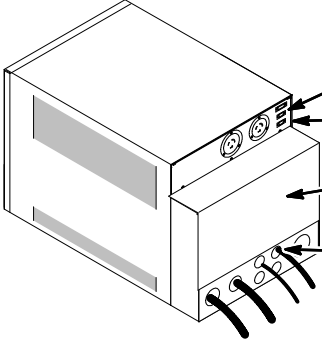

- ④ Connect Run 703 to J2.
- ③ Connect Run 706 to J3.
- ② Attach rear PDU module cover.
- ① Tighten clamps of interface panel to secure cables in place.

- CONNECT RUNS 762, 763, & 764 OUTPUT CRADIENT CABLES

NOTE: Output cables (Runs 762, 763, and 764) were previously routed, cut to length, and terminated.

- ① Loosen screws on J5 clamp on bottom of shelf below. Insert ends of Run 764 gradient output cable into Cabinet Interface J5. (Runs 762 will insert into J3, and Run 763 into J4)

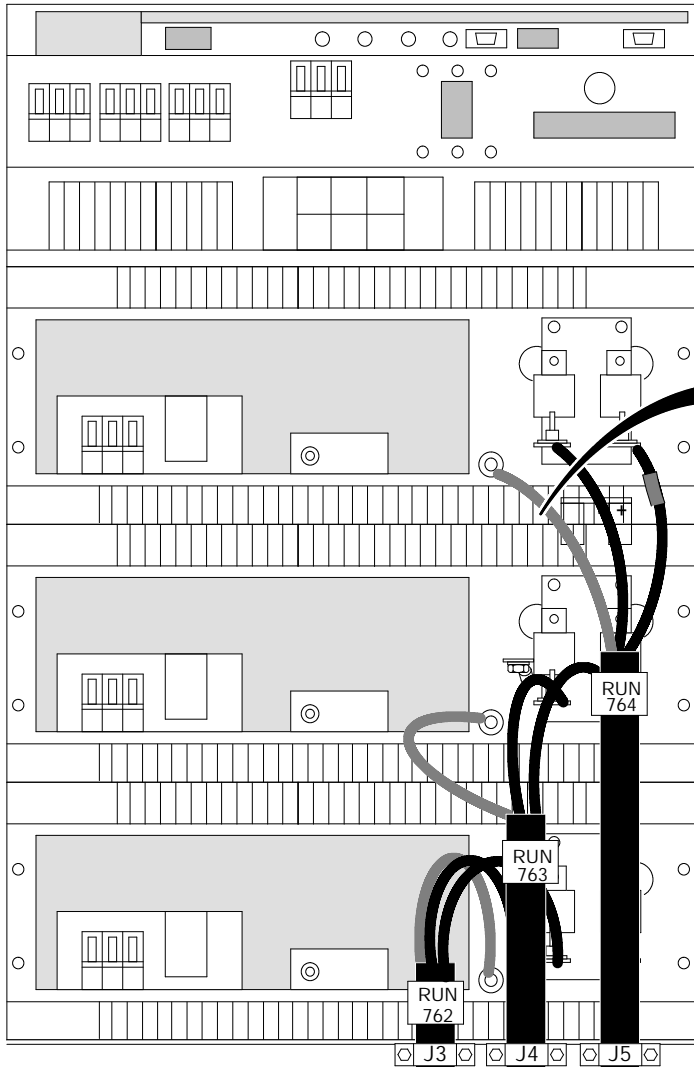
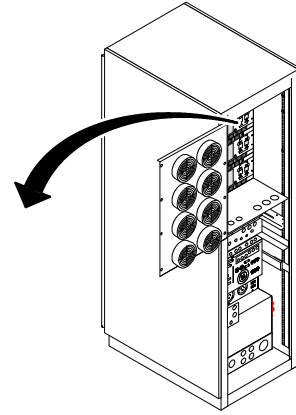

- ② Connect gradient output cables with red-taped (+) #1 wires to + output terminals and black (-) #2 wires to - output terminals of the Z Amplifier.

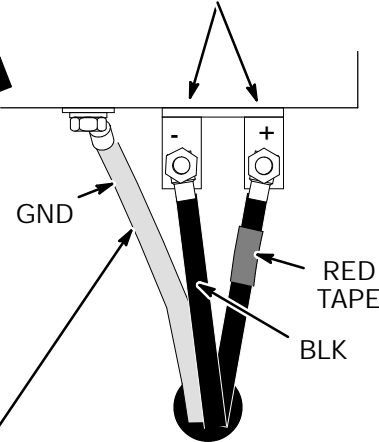

- ③ Connect the GND leads of each run to the Ground stud located on the back of amplifier.
- ④ Tighten clamp block to secure output power cable to I/F panel.

- ⑤ Repeat steps 1, 2, 3, and 4 for connection of Runs 762 and 763 to X and Y Amplifiers.

- ROUTE/CONNECT FIBER OPTICS AND RUN 229

CAUTION

Handle fiber optic cables carefully. Do not bend fiber optic cables to radius smaller than two inches. Avoid scratching connector ends. Keep connectors protected until ready to connect. Routing of fiber optic cables must be done with care to prevent damage to optical fibers.

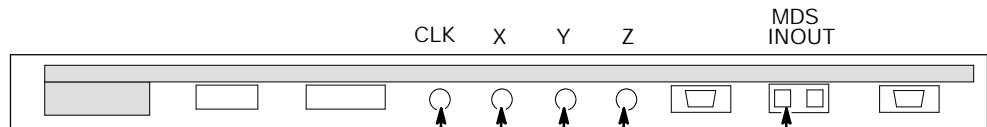

8 Connect fiber optics to SCA module according to labels.

7 Route fiber optic Runs 710 along side of cabinet to System Control Assembly module.

6 Attach Runs 710 to opening in shelf below Gradients.

5 Dress and secure fiber optic cables along route from Module to I/F Panel. While checking Fiber Optic Cable routing, push RF System Support Module into cabinet.

4 Connect fiber optic cable Run 708 to Transmit (TX).

3 Extend forward RF System Support Module into servicing position.

2 Attach Run 708 to I/F TX*.
* Instructions provided with connectors.

1 Attach Run 229 to J3

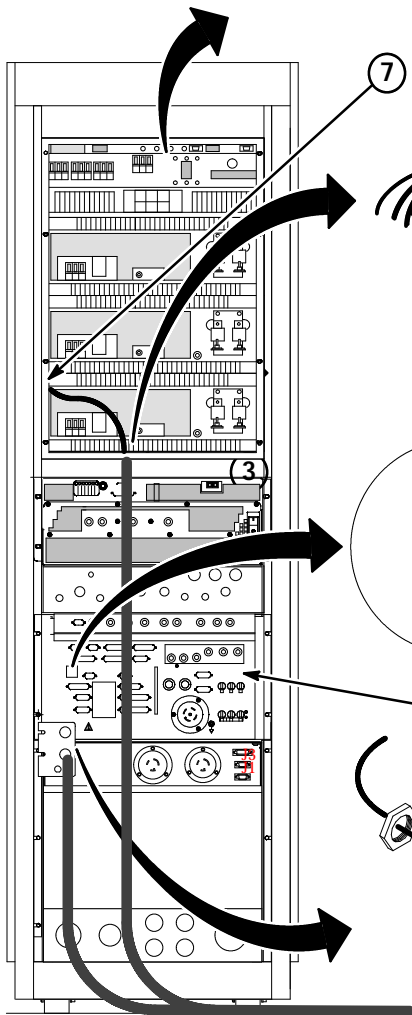

- SYSTEM SUPPORT MODULE CABLE CONNECTIONS

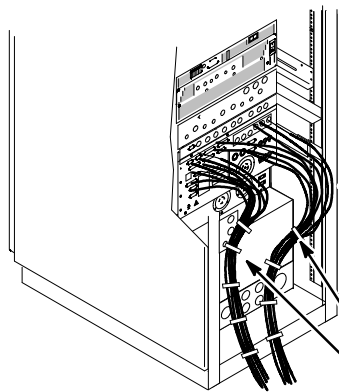

CAUTION

All cables connected to System Support Module Interface Panel must have a service loop of approximately 2 feet (610mm) to allow enough slack for serviceability when Module is moved completely forward.

① Connect cables to System Support Module.

Note:

If needed, refer to Overview: Section 2 - System Cables, for Run descriptions and designator information located at end of each cable.

② Dress and secure cables connected to System Support Module. Verify sufficient slack by moving Module completely forward and back again. Adjust as necessary.

- CONNECT RUNS 887, 888 and 935 TO RF INTERFACE (RFI) MODULE

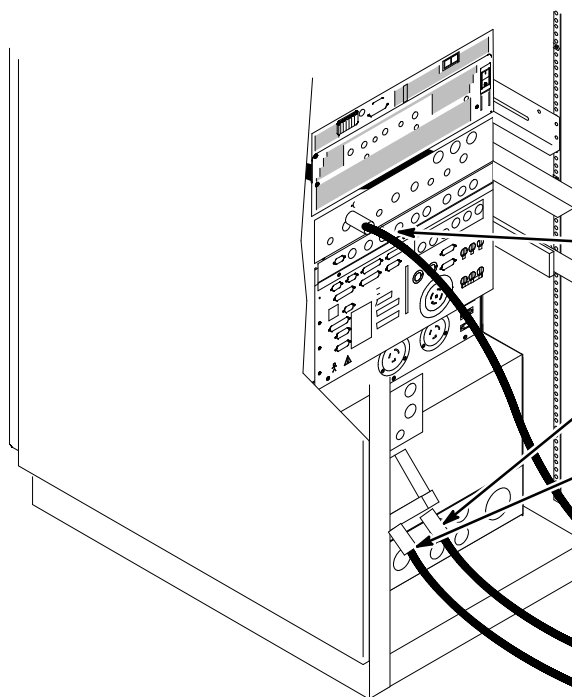

① Connect extension cable Run 745 (46- 287668G5) to J4 Body Output on RFI Module.

② Connect extension cable Run 933 (46- 287688G8) to N. O. on the R/L Switch.

③ Connect extension cable Run 932 (46- 287688G7) to N. C. on the R/L Switch.

④ Connect Run 935 to Run 745.

⑤ Connect Run 888 to Run 933.

⑥ Connect Run 887 to Run 932.

- ATTACH INSITE CABINET MAGNET

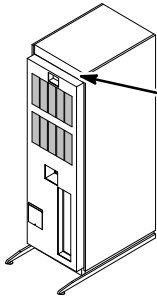

- ① Attach all front and rear covers.
- ② From the OpenSpeed InSite Kit (46- 301708G5), locate the "Power (GRFD)" cabinet magnet (46- 320095P15). Attach to front of cabinet as shown.