

SERVICE MANUAL



Document 780031

Revision F

**GE Signa^â OvationTM
MAGNA 5000
PHASED ARRAY CTL SPINE COIL**

GE Catalog Part Number: M20012BC

USAI Part Number: 160056

Copyright © 2002 by USA Instruments, Inc.

DAMAGE IN TRANSPORTATION

All packages should be closely examined at time of delivery. If damage is apparent, have notation "**damage in shipment**" written on **all** copies of the freight or express bill **before** delivery is accepted or "signed for" by a General Electric representative or a hospital receiving agent. Whether noted or concealed, damage **MUST** be reported to the carrier **immediately** upon discovery, or in any event, within **14** days after receipt, and the contents and containers held for inspection by the carrier. A transportation company will not pay a claim for damage if an inspection is not requested within this **14**-day period.

Immediately complete a "Damage Loss Claim Form", available via MS Exchange Mail, after the damage is found.

MS Exchange Path:

Outlook/Public Folder/All Public Folders/Medical Systems/!Global Initiatives/Information Management/Forms/Common Forms/DAMAGE LOSS CLAIM FORM.

Send the completed form to the email address listed in the form.

For more information about the Transportation Claim Procedure, access the GE Medical Systems Intranet and enter the following URL address (case sensitive):

<ftp://3.87.40.2/globepro/qualsys/Docs/190016MF.PDF>

Language Policy For Service Documentation (Dir. 2128126)

WARNING

- This service manual is available in English only.
- If a customer's service provider requires a language other than English, it is the customer's responsibility to provide translation services.
- Do not attempt to service the equipment unless this service manual has been consulted and is understood.
- Failure to heed this warning may result in injury to the service provider, operator or patient from electric shock, mechanical or other hazards.

AVERTISSEMENT

- Ce manuel de maintenance n'est disponible qu'en anglais.
- Si le technicien du client a besoin de ce manuel dans une autre langue que l'anglais, c'est au client qu'il incombe de le faire traduire.
- Ne pas tenter d'intervention sur les équipements tant que le manuel service n'a pas été consulté et compris.
- Le non-respect de cet avertissement peut entraîner chez le technicien, l'opérateur ou le patient des blessures dues à des dangers électriques, mécaniques ou autres.

WARNUNG

- Dieses kundendienst-handbuch existiert nur in englischer sprache.
- Falls ein fremder kundendienst eine andere sprache benötigt, ist es aufgabe des kunden für eine entsprechende übersetzung zu sorgen.
- Versuchen sie nicht, das gerät zu reparieren, bevor dieses kundendienst-handbuch nicht zu rate gezogen und verstanden wurde.
- Wird diese warnung nicht beachtet, so kann es zu verletzungen des kundendiensttechnikers, des bedieners oder des patienten durch elektrische schläge, mechanische oder sonstige gefahren kommen.

AVISO

- Este manual de servicio sólo existe en inglés.
- Si algún proveedor de servicios ajeno a gems solicita un idioma que no sea el inglés, es responsabilidad del cliente ofrecer un servicio de traducción.
- No se deberá dar servicio técnico al equipo, sin haber consultado y comprendido este manual de servicio.
- La no observancia del presente aviso puede dar lugar a que el proveedor de servicios, el operador o el paciente sufran lesiones provocadas por causas eléctricas, mecánicas o de otra naturaleza.

ATENÇÃO

- Este manual de assistência técnica só se encontra disponível em inglês.
- Se qualquer outro serviço de assistência técnica, que não a gems, solicitar estes manuais noutro idioma, é da responsabilidade do cliente fornecer os serviços de tradução.
- Não tente reparar o equipamento sem ter consultado e compreendido este manual de assistência técnica.
- Não cumprimento deste aviso pode por em perigo a segurança do técnico, operador ou paciente devido a' choques elétricos, mecânicos ou outros.

AVVERTENZA

- Il presente manuale di manutenzione è disponibile soltanto in inglese.
- Se un addetto alla manutenzione esterno alla gems richiede il manuale in una lingua diversa, il cliente è tenuto a provvedere direttamente alla traduzione.
- Si proceda alla manutenzione dell'apparecchiatura solo dopo aver consultato il presente manuale ed averne compreso il contenuto.
- Non tenere conto della presente avvertenza potrebbe far compiere operazioni da cui derivino lesioni all'addetto alla manutenzione, all'utilizzatore ed al paziente per folgorazione elettrica, per urti meccanici od altri rischi.

警告

- ・このサービスマニュアルは英語版しかありません。
- ・GEMS以外でサービスを担当される業者が英語以外の言語を要求される場合、翻訳作業はその業者の責任で行うものとさせていただきます。
- ・このサービスマニュアルを熟読し、理解せずに装置のサービスを行わないでください。
- ・この警告に従わない場合、サービスを担当される方、操作員あるいは患者さんが、感電や機械的又はその他の危険により負傷する可能性があります。

注意:

- 本维修手册仅存有英文本。
- 非 GEMS 公司的维修员要求非英文本的维修手册时，客户需自行负责翻译。
- 未详细阅读和完全了解本手册之前，不得进行维修。
- 忽略本注意事项会对维修员，操作员或病人造成触电，机械伤害或其他伤害。

TABLE OF CONTENTS

Damage in Transportation	2
Section 1 – Introduction.....	6
1-1 Product Identification and Shipping List.....	6
1-2 Compatibility.....	7
1-3 Related Documentation.....	7
1-4 Environmental Requirements.....	7
1-5 Theory of Operation.....	7
Section 2 – Setup and Calibration.....	9
2-1 Coil Installation	9
2-1-1 Special Install Notes	9
2-1-2 Configuration	9
2-2 Installation Functional Checks	9
2-3 Periodic Quality Assurance Check	9
2-4 Tuning Procedure	10
2-4-1 Tools and Accessories Required.....	10
2-4-2 Procedure.....	10
2-4-3 Procedure for the C-Spine Mode Channel 1	11
2-4-4 Procedure for the C-Spine Mode Channel 2.....	14
2-4-5 Procedure for the T-Spine Mode	14
2-4-6 Procedure for the L-Spine Mode	15
Section 3 – Functional Checks	17
3-1 Scanner Verification	17
3-2 Coil Imaging Performance Verification.....	17
3-2-1 Tools Required	17
3-2-2 Explanation of Procedure	17
3-2-3 Scan Setup.....	17
3-2-4 Phantom Scan	20
3-2-5 Determine the MFO Software Version of the System	20
3-2-6 SNR Check Method for MFO Systems.....	20
3-2-7 SNR Check Method for MFO2 or Later Systems	24
3-3 External Cable Check	25
3-4 PIN Diodes Check	25
3-5 Mechanical Hardware Check.....	25
3-6 Troubleshooting Tips	26
3-7 Troubleshooting Strategy	28
Section 4 – Maintenance.....	34
4-1 Coil Care.....	34
4-2 Special Care Requirements.....	34
Section 5 – Replacement	35
5-1 External Cable Replacement	35
Section 6 – Renewal Parts	36
6-1 Field Replaceable Units	36
6-2 Other Replaceable Accessories	36
Section 7 – Appendix.....	37
7-1 SNR Data Sheet	37
7-2 Troubleshooting SNR Check Sheet.....	38
7-3 Schematic.....	39
7-4 Configuration	40
Revision History	41

SECTION 1 – INTRODUCTION

1-1 Product Identification and Shipping List

To identify the Magna 5000 Phased Array CTL Spine Coil, refer to the coil label underneath the coil (as shown in *Figure 1*).

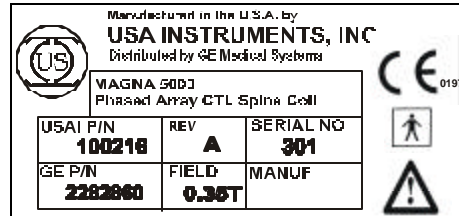

Figure 1: Coil label.

Figure 2 shows a picture of the Magna 5000 Phased Array CTL Spine Coil.



Figure 2: The Phased Array CTL Spine Coil.

SHIPPING LIST – TABLE 1-1

Box #	Part Name	GE Part #	USAI Part #	Qty
1	Coil	2282860	100216	1
1	Patient Comfort Pad	2284651	150149	1
1	Neck Support Pad	E8801TK	150170	1
2	CT Phantom	2264744-7	150161	1
3 & 4	TL Phantom	2264744-8	150162	2
1	Operator's Guide	2282850	770050	1
1	Service Manual	2284652	780031	1
1	Service Tuning Cable Set	2284647	150239	1

1-2 Compatibility

This coil is compatible with the GE Signa[®] Ovation[™] 0.35T system.

1-3 Related Documentation

Operator's Guide, GE Part Number 2282850.

Signa[®] Ovation[™] MR Service Document CD-ROM, 2283084.

1-4 Environmental Requirements

Storage Requirements

Coil should be stored in the scanner room.

Dimensions

86.30 cm x 57.05 cm x 38.91 cm (34" x 22.46" x 15.32")

Weight

10.4 kg (22.93 lbs.)

1-5 Theory of Operation

The block diagram of the Magna 5000 Phased Array CTL Spine Coil is shown in *Figure 3* and the block diagram of the circuit layout is shown in *Figure 4*. Also refer to the schematic in the Appendix. The coil is designed for obtaining diagnostic images of the whole human spine, specifically: cervical, thoracic and lumbar. The coil consists of: (1) a main coil base for imaging the entire spine, (2) a removable anterior neck and (3) three "bridges" consisting of coil elements for enhanced imaging of the thoracic and lumbar spine. The coil has an array of seven coil elements. These coil elements are arranged primarily as saddle and loop coil configurations. Depending on the anatomy imaged, the user is able to select different imaging modes to selectively image the spine anatomy. The modes are enabled by the clinical user at the console.

The Phased Array CTL Spine Coil is a receive-only coil. The coil is actively decoupled from the RF transmit coil during transmit by means of a RF choking circuit. The choking circuit elements are switched on and off by pin diodes or by small-signal diodes. During body coil transmission, the pin diodes are turned on, as shorted circuits, with a forward bias DC source provided by the MR system (active decoupling). The small-signal diodes are turned on by the induced RF voltage in the chokes, coupled from the transmit field (passive decoupling). When either the pin diodes or the small-signal diodes are turned on, each of these RF choking elements becomes very high in impedance (typically above 2 kilo-ohm), compared with the other circuit elements (less than 70 ohm). These high impedance elements in the coil segregate the coil circuitry into several isolated electrical segments, preventing any current flow in the coil circuit.

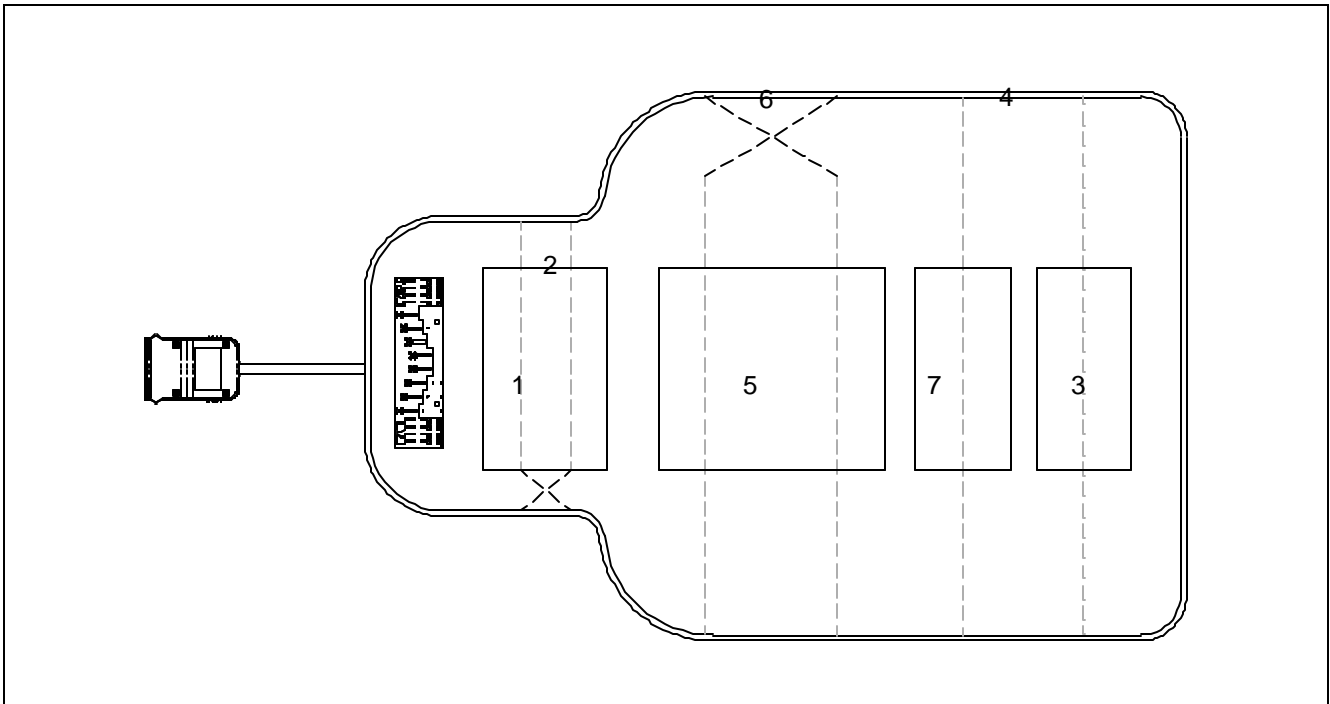

Figure 3: Block diagram of the coil.

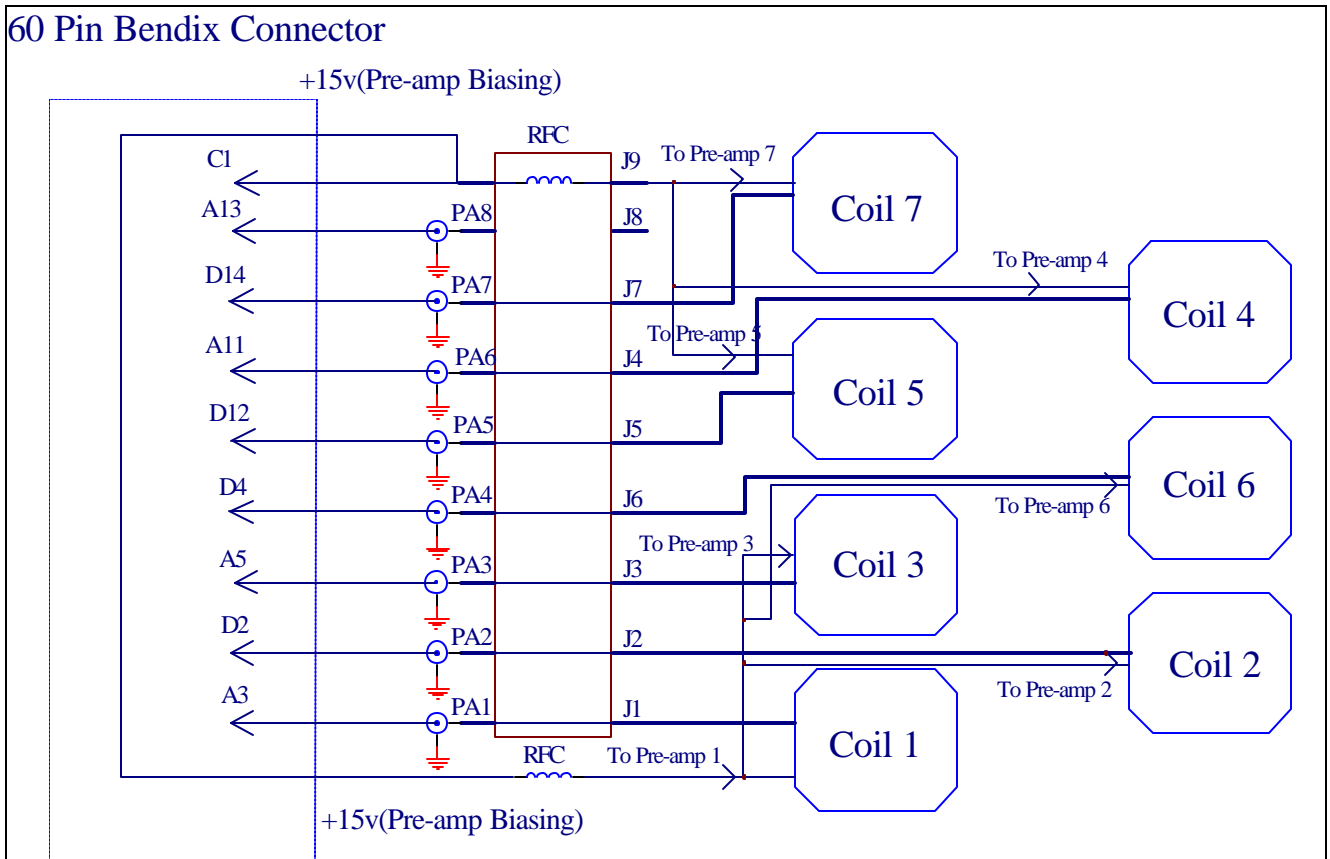

Figure 4: Block diagram of the circuit layout.

SECTION 2 – SETUP AND CALIBRATION

2-1 Coil Installation

2-1-1 Special Install Notes

None.

2-1-2 Configuration

The system will automatically recognize the coil using the Coil ID feature. No configuration should be required. If the system doesn't automatically recognize the coil, install the configuration information. For reference, the configuration information is included in the Appendix; however, that configuration is only current as of the printing of this manual.

2-2 Installation Functional Checks

1. From the Scan Desktop, start new scan by selecting [**New Pt**]; set **Patient ID** to "geservice" and **Patient Weight** to "111" pounds. Click [**Patient Position**] to open protocols window.
2. Plug the coil into the patient table and verify the coil indicator light at the side of the coil port turns green. A green light indicates the system hardware identifies the coil.
3. At the console, verify the Coil has been properly identified by the system: correct name in **Coil** field and correct picture on the screen.
4. Perform system level Signal to Noise Check. Refer to Service Methods CD; System Level Procedures; Functional Checks; Signal to Noise Check.
5. Perform Section 3-2 Coil Imaging Performance Verification.

2-3 Periodic Quality Assurance Check

On a periodic basis, such as during planned maintenance, perform the quality assurance checks as outlined below to ensure the coil is operating properly.

1. Check external cable for cracks or cuts.
2. Perform Section 3-2 Coil Imaging Performance Verification and record data values in Data Sheet.

2-4 Tuning Procedure

2-4-1 Tools and Accessories Required

TOOLS AND ACCESSORIES – TABLE 2-4-1

Description
Slotted screwdriver
Tuning cable, GE Part #2284647
Vector Impedance Meter, HP4193 (or equivalent)

2-4-2 Procedure

1. Remove bottom cover of the coil (18 screws).
2. Remove the side panels from the side of the coil (see *Figure 5*).

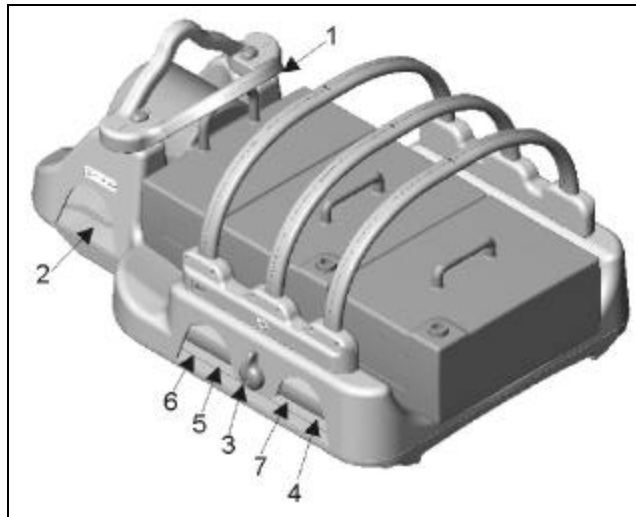

Figure 5: Coil, phantoms and channel tuning locations, with side panels removed.

3. Set-up the impedance meter to the system frequency f_0 .
4. Tune each channel according to the following offset:
 - Channel 1: $f = f_0 - 10 \text{ kHz}$
 - Channel 2: $f = f_0$
 - Channel 3: $f = f_0$
 - Channel 4: $f = f_0 + 10 \text{ kHz}$
 - Channel 5: $f = f_0 + 10 \text{ kHz}$
 - Channel 6: $f = f_0 + 10 \text{ kHz}$
 - Channel 7: $f = f_0 - 10 \text{ kHz}$

2-4-3 Procedure for the C-Spine Mode Channel 1

1. Connect the test cable (SMB connector end) to the test point of channel 1 near Preamp 1 (see *Figure 6*).

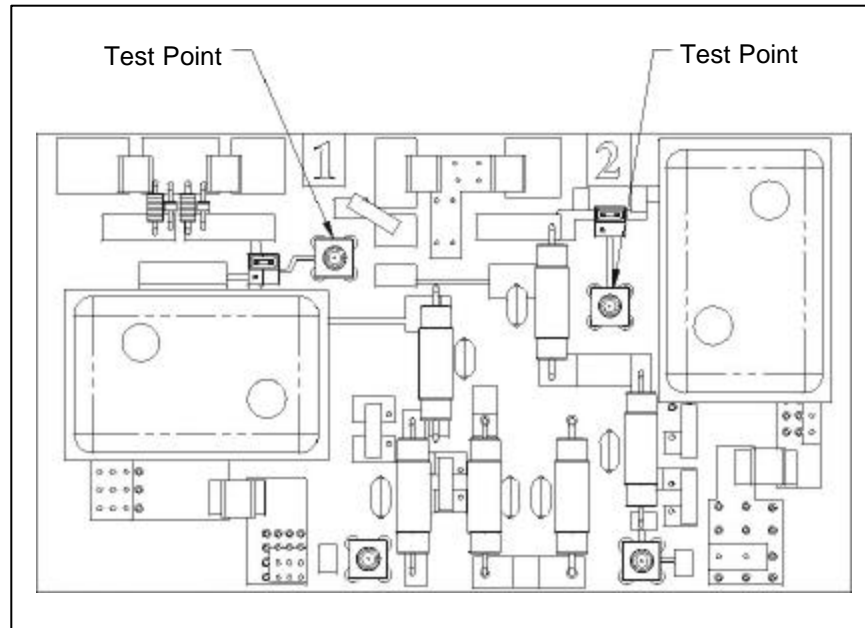

Figure 6: Test points for test cable.

2. To test Channel 1, unplug only jumper #1 near Preamp 1, and then plug jumper #1 into the Tune Mode position (see *Figure 7*).

Note: The procedure in Step 2 applies to the tuning of each channel. Always use the jumper corresponding to the Channel number. Do not change the jumper position for any other Channel except the Channel being tuned. Only the jumper of the Channel being tuned should be in tuning mode. All other jumpers should be in scan mode.

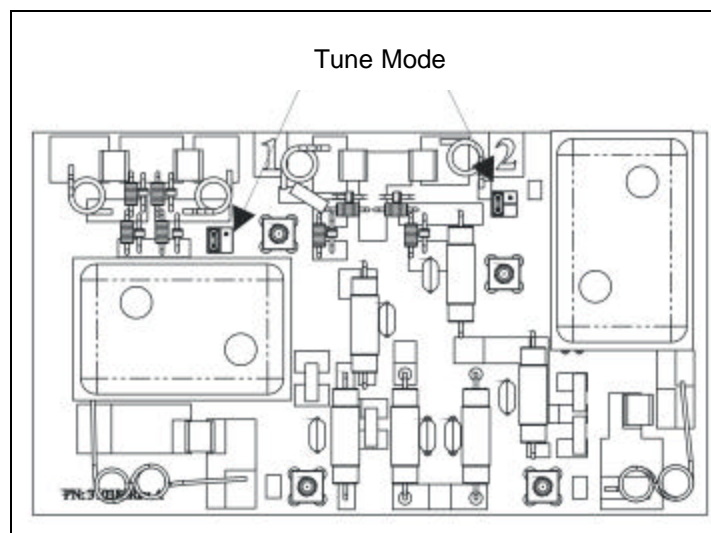

Figure 7: Jumper position for tuning mode.

3. Place the coil on the patient table and load it with the phantom set (see *Figure 8*).
4. Put the cervical bridge on the coil.
5. Connect the coil cable to the system.



Figure 8: Phantom set on the coil in the system.

6. Landmark the coil at the center of the C-Spine area (see *Figure 9*).
7. Set the QA protocol for a C-Spine scan.
8. Select “Save Series” and “Prepare to Scan”.

CAUTION

Before starting a manual prescan, the tuning cable must be disconnected from the impedance meter; otherwise the RF power will damage the VIM.

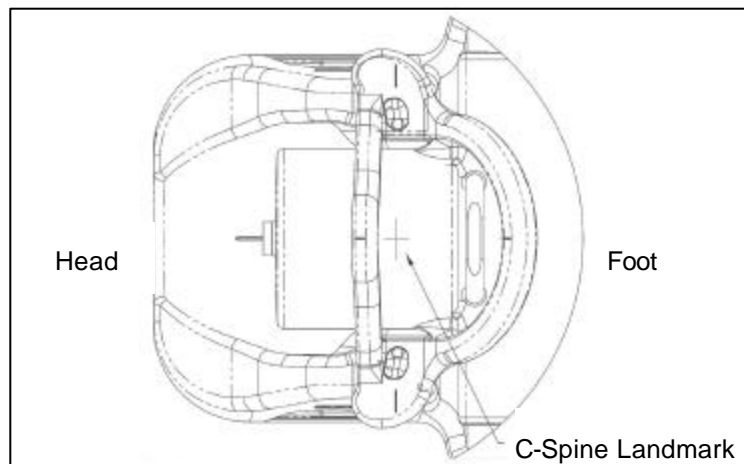

Figure 9: C-Spine landmark.

9. Turn off the system **RF** power switch on the UCERD board and start a manual prescan. Select the T/R scan button, then end manual prescan to insure that the body coil is in "receive" mode.
10. Connect the test cable (BNC connector end) to the impedance meter.
11. Adjust the tuning capacitor for channel one (see *Figure 5* for tuning location) until the phase on the impedance analyzer is 0 degrees (± 5 degrees) at a **frequency of f0-10 kHz**.



Figure 10: Adjusting the tuning capacitor.

12. Disconnect the test cable from the test point of channel. Disconnect the coil cable from the system.
13. Put the test jumper of channel 1 to the original scan mode position (see *Figure 11*).

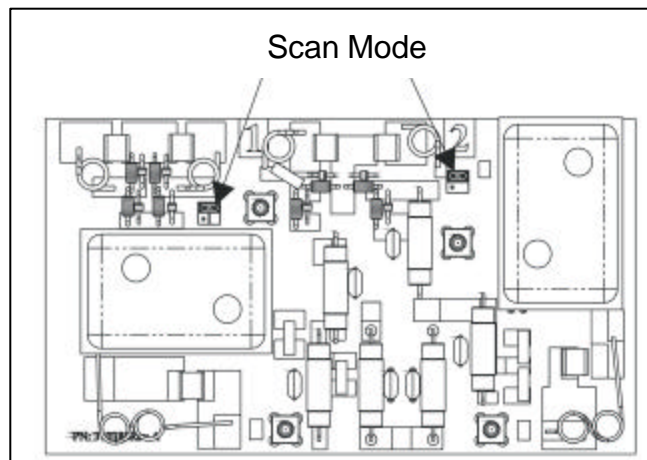

Figure 11: Jumper position for scan mode.

2-4-4 Procedure for the C-Spine Mode Channel 2

1. Move the jumper near Preamp 2 to the Tune Mode position and connect the test cable to the test point of channel 2. Refer to *Figure 5* and *Figure 6*.
2. Place the coil on the patient table and load it with the phantom set.
3. Put the cervical bridge on the coil.
4. Connect the coil cable to the system.
5. Landmark the coil at the center of the C-Spine area. Refer to *Figure 9*.
6. Adjust the tuning capacitor for channel 2 (see *Figure 5* for tuning location) until the phase on the impedance analyzer is 0 degrees (+/- 5 degrees) at **system frequency f₀**.
7. Disconnect the test cable from the test point of channel 2.
8. Put test jumper of channel 2 to the original scan mode position (refer to *Figure 11*).

2-4-5 Procedure for the T-Spine Mode

1. Connect the test cable to the test point of channel 5 near the Preamp 5.
2. Move the jumper of channel 5 to Tune Mode position (refer to *Figure 7*).
3. Landmark the coil in the center of the T-Spine section (see *Figure 12*).

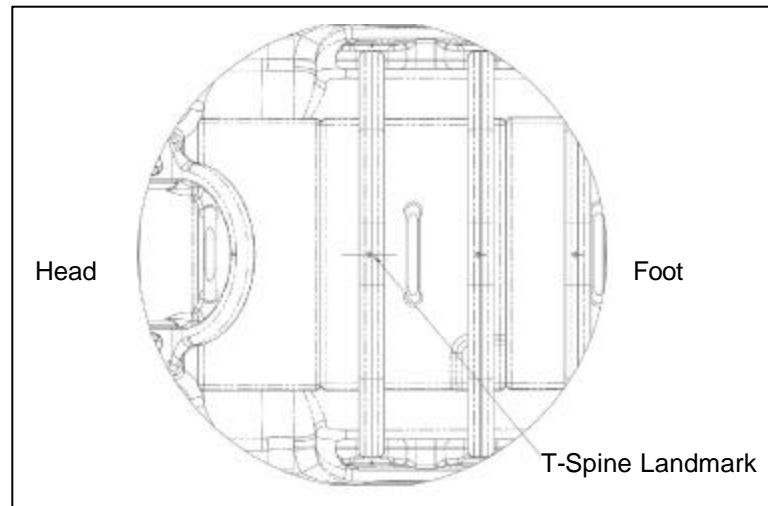

Figure 12: T-Spine landmark.

4. Set QA protocol for T-Spine mode and select "Save Series" and "Prepare to Scan." Remove tuning cable from VIM if connected.
5. Start manual prescan. Select T/R scan button; then end manual prescan. This is done to insure that the body coil is in "receive mode."
6. Adjust the tuning capacitor for channel 5 (see *Figure 5* for tuning location) until the phase on the impedance analyzer is 0 degrees (± 5 degrees) at **$f = f_0 + 10$ kHz**.
7. Remove the test cable and put the test jumper of channel 5 to the original scan mode position (refer to *Figure 11*).

- Repeat the same procedure as described above for channel 6. Adjust the tuning capacitor for channel 6 (see *Figure 5* for tuning location) until the phase on the impedance analyzer is 0 degrees (+/- 5 degrees) at $f = f_0 + 10 \text{ kHz}$.
- Repeat the same procedure as described above for channel 7. Adjust the tuning capacitor for channel 7 (see *Figure 5* for tuning location) until the phase on the impedance analyzer is 0 degrees (+/- 5 degrees) at $f = f_0 - 10 \text{ kHz}$.

2-4-6 Procedure for the L-Spine Mode

- Connect the test cable to the test point of channel 3 near the Preamp 3 (refer to *Figure 6*).
- Move the jumper of TP1 of channel 3 to Tune Mode position and connect the test cable (BNC connector end) to the impedance meter (refer to *Figure 7*).
- Landmark the coil in the center of the L-Spine section (see *Figure 13*).

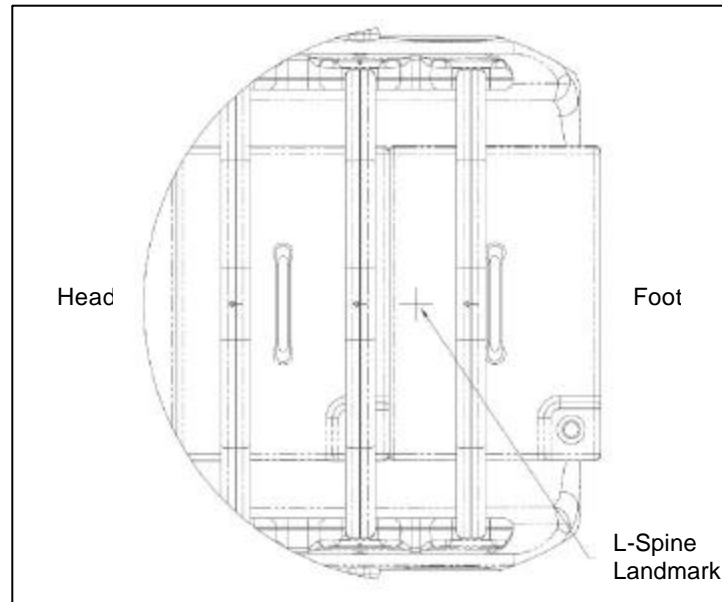

Figure 13: L-Spine landmark.

- Set QA protocol for L-Spine mode and select "Save Series" and "Prepare to Scan". Remove tuning cable from VIM if connected.
- Start manual prescan. Select T/R scan button; then end manual prescan. This is done to insure that the body coil is in "receive mode."
- Adjust the tuning capacitor for channel 3 (see *Figure 5* for tuning location) until the phase on the impedance analyzer is 0 degrees (+/- 5 degrees) at **system frequency f_0** .
- Remove the test cable and put the test jumper of channel 3 to the original scan mode position (refer to *Figure 9*).
- Repeat the same procedure as described above for channel 4. Adjust the tuning capacitor for channel 4 (see *Figure 5* for tuning location) until the phase on the impedance analyzer is 0 degrees (+/- 5 degrees) at $f = f_0 + 10 \text{ kHz}$.

Final Assembly

1. Check that all jumpers are in Scan Mode position (refer to *Figure 11*).
2. Remove the tuning cable from the VIM.
3. Turn the system **RF** power on.
4. Run a QA scan for C, T, L modes using the QA protocol. Check each interim image of each element.
5. If there is no image from a Channel, check the corresponding jumper position. The jumper should be in Scan Mode. If the jumper is in Scan Mode and there is no image, replace the jumper with the spare jumper attached.
6. Replace the side panels and bottom covers.

SECTION 3 – FUNCTIONAL CHECKS

3-1 Scanner Verification

Perform system level Signal to Noise Check. Refer to Service Methods CD; System Level Procedures; Functional Checks; Signal to Noise Check.

3-2 Coil Imaging Performance Verification

3-2-1 Tools Required

TOOLS REQUIRED – TABLE 3-2-1

Description	GE Part #	USAI Part #	Qty
CT Phantom	2264744-7	150161	1
TL Phantom	2264744-8	150162	2

3-2-2 Explanation of Procedure

The image quality check consists of three scans: one for the cervical region, one for the thoracic region, and one for lumbar region of the coil.

Symbols for Hardware and Software Keys

Hardware keys are underlined>. Software keys are indicated using brackets [].

3-2-3 Scan Setup

- From the Scan Desktop, start new scan by selecting [**New Pt**]; set **Patient ID** to “geservice”, **Patient Name** to “QA Scan” and **Patient Weight** to “111” pounds or “50”kg.

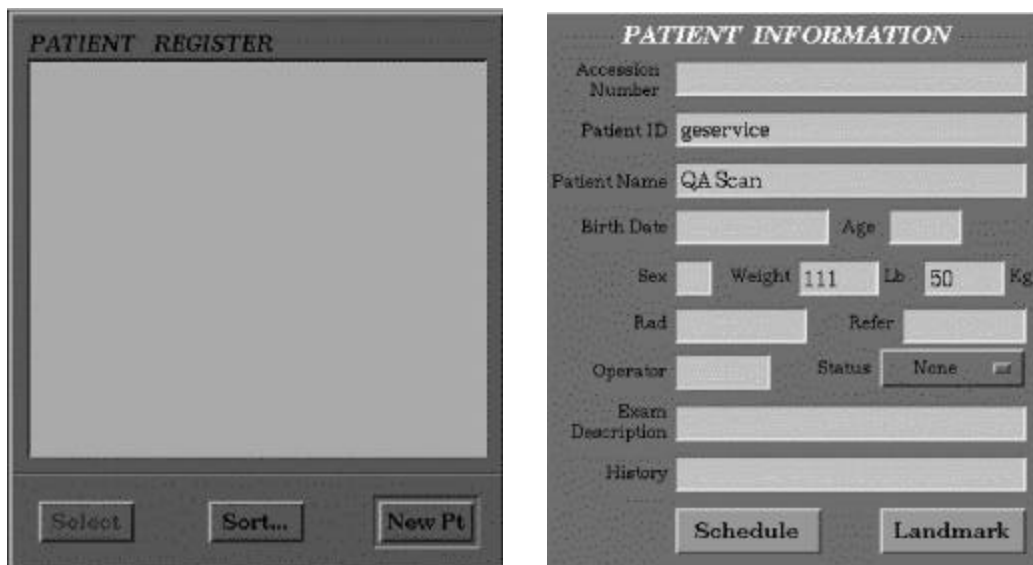

Figure 14: New patient setup and patient information.

2. Remove any other surface coil (if present) from the cradle. Place the coil near the top of the cradle. Position the phantom set on the coil (without the patient comfort pad as shown in *Figure 15*). Connect the coil connector to the coil port.



Figure 15: Phantom set.

3. At the magnet, press the **Alignment Light** button to turn on the light. Move the cradle to align the coil to the alignment lights (use the alignment marks on the coil for guidance). Press the **Landmark** button to landmark the alignment.

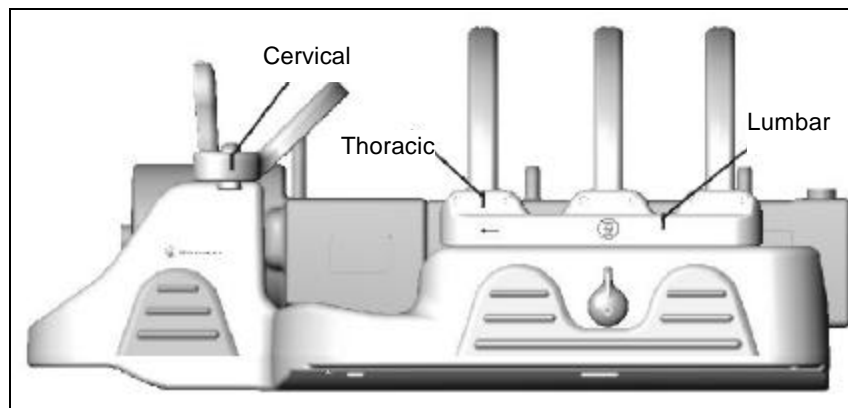

Figure 16: Coil landmarks.

4. Move the coil to scan position by pushing the **Move to Scan** button, ensuring cable does not get snagged.
5. At the console, verify the Coil has been properly identified by the system: correct picture on the screen and correct name in **Coil** field. If system does not recognize coil, refer to Section 2 – Setup and Calibration.
6. Set the protocols from Scan Protocols – Table 3-2-3.
7. Select [**Save Series**] to download the protocols. Select [**Prepare to Scan**].

SCAN PROTOCOLS – TABLE 3-2-3

Patient/Exam Information	
Patient ID	geservice
Patient Name	QA Scan
Patient Weight	111 lbs. (50 kg)
Landmark	Nasion
Table Entry	Center
Patient Position	
Patient Position	Supine
Patient Entry	Head First
Coil	Cervical CTL, Thoracic CTL, Lumbar CTL
Series Description	<i>Leave Blank</i>
Imaging Parameters	
Plane	Sagittal
Mode	2D
Pulse Seq	Spin Echo
Imaging Options	None
PSD Name	<i>Leave Blank</i>
Protocol	<i>Leave Blank</i>
Scan Timing	
# of Echoes	1
TE	25.0
TR	500
Bandwidth	10.42
Additional Parameters	
<i>no entries required in this area</i>	
Acquisition Time	
Freq	256
Phase	256
NEX	1.0
Phase FOV	1.0
Freq DIR	S/I
Auto Center Freq	Peak
Autoshim	On
Contrast	Off
Scanning Range	
FOV	40
Slice Thickness	5
Spacing	0

	I/S Center	P/A Center	R/L Center
Start	0	0	0
End	0		
# Slices	1		

3-2-4 Phantom Scan

1. Run **[Auto Prescan]**. Record the R1, R2 and TG values on the SNR Data Sheet (found in the Appendix).
2. Run **[Scan]**. After the first scan, select **[Scan]** again. Do not run a Prescan between the two scans.
3. Repeat the procedure to obtain phantom images from the thoracic and lumbar regions.

3-2-5 Determine the MFO Software Version of the System

To determine the software version of the system:

1. Open the Service Desktop and select **[Cshell]**.
2. From the Cshell, type “**cat /mr.closure.MrpApps**”. Press **Return**.

```
winterm
-----
{} [] cat /mr.closure.MrpApps           return
{} [] MFO2_**
```

Figure 17: Determining the MFO version – example of MFO2 system.

If the displayed value is MFO_**, proceed to Section 3-2-6 SNR Check Method for MFO Systems.

If the displayed value is MFO2_** or higher, proceed to Section 3-2-7 SNR Check Method for MFO2 or Later Systems.

3-2-6 SNR Check Method for MFO Systems

Create Subtraction Images

1. Select **[Display Icon]**.
2. Select the exam named “QA Scan”.
3. Select **[Add/Sub]** from browser.

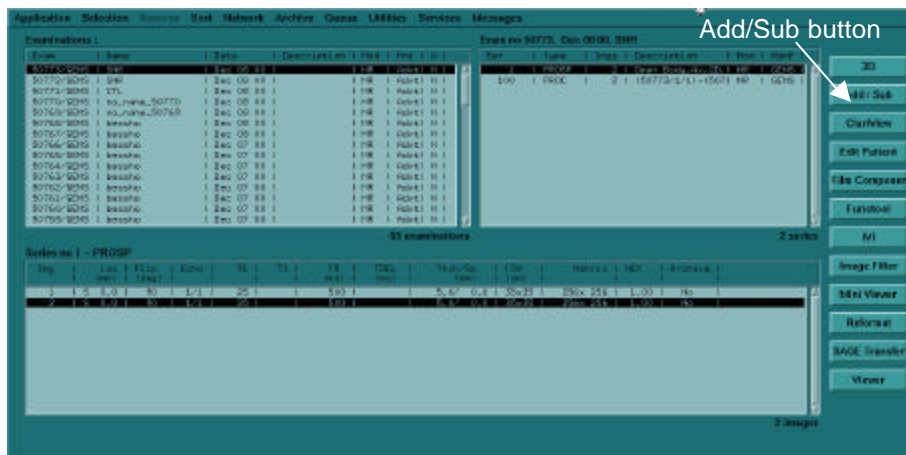

Figure 18: Browser with Add/Sub button.

4. Select MODE [-]; select [**Accept Negative Pixels**].
5. Select the first image from the browser; then select Image Combination [**Select Set**] (left button on the Image Combination Window).
6. Select the second image from the browser; then select Image Combination [**Select Set**] (right button on the Image Combination Window).
7. Select [=].
8. Repeat the procedure to create subtraction images for thoracic and lumbar modes.

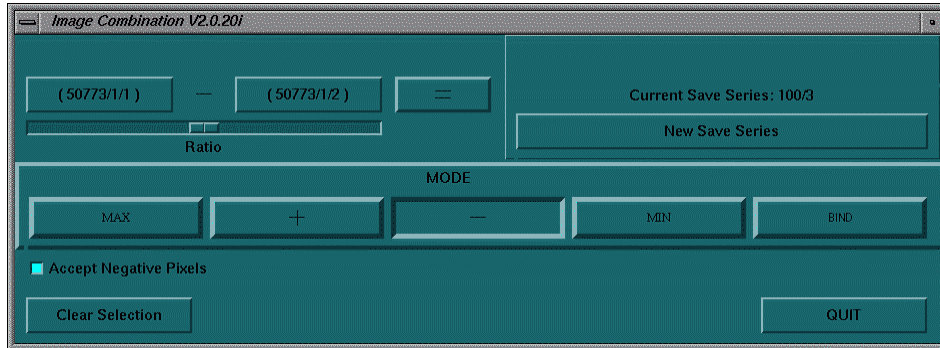

Figure 19: Image Combination Window.

Setting the Cursor

1. Select [**Display Icon**] to display the browser.
2. Select the “QA Scan” exam.
3. Select the image to measure and select [**Mini Viewer**].
4. Select [Grid] to set cursor.
5. Select the rectangular cursor in [Measure]. Adjust the cursor size to 4cm x 4cm. Move the cursor to the right at P 50mm and S/I 0mm. Copy the cursor (**CTRL + C**).
6. Measure the following ROIs with phantom and subtracted images. Use cursor paste (**CTRL + V**) to easily set the cursor.

ROI SELECTION – TABLE 3-2-6

Configuration	Cursor	ROI Size	ROI Area (mm ²)	ROI Center Position (mm)
Cervical	Rectangular	A/P 4cm x S/I 4cm	1600 (+/- 40)	P 50, S/I 0
Thoracic	Rectangular	A/P 4cm x S/I 4cm	1600 (+/- 40)	P 50, S 100
Thoracic	Rectangular	A/P 4cm x S/I 4cm	1600 (+/- 40)	P 50, S/I 0
Thoracic	Rectangular	A/P 4cm x S/I 4cm	1600 (+/- 40)	P 50, I 100
Lumbar	Rectangular	A/P 4cm x S/I 4cm	1600 (+/- 40)	P 50, S 100
Lumbar	Rectangular	A/P 4cm x S/I 4cm	1600 (+/- 40)	P 50, I 20
Lumbar	Rectangular	A/P 4cm x S/I 4cm	1600 (+/- 40)	P 50, I 100

SNR Image Analysis

Signal Measurement

1. Measure the **mean** values of a pair of the phantom images and record them on the SNR worksheet in the Appendix.
2. Measure and record the mean values of the other modes.
3. Refer to channel images shown in *Figures 20* through *22*.

Noise Measurement

1. Noise measurement is performed at the same location as Signal measurements (refer to ROI Selection – Table 3-2-6).
2. Select subtracted images in the browser using [**Mini Viewer**]. The series of these images are 100s.
3. Measure the **standard deviation** value of the subtracted images and record them on the SNR worksheet in the Appendix.
4. Measure and record the standard deviation values for the other modes.

SNR Measurement

SNR is calculated as follows:

$$SNR = [(mean\ value\ 1) + (mean\ value\ 2)] / (SD \times 1.414)$$

SNR Specification

SNR should be greater than or equal to the following numbers:

Configuration (composite)	ROI Position	Spec
Cervical	P 50, S/I 0	269
Thoracic	P 50, S 100	89
Thoracic	P 50, S/I 0	104
Thoracic	P 50, I 100	118
Lumbar	P 50, S 100	105
Lumbar	P 50, I 20	114
Lumbar	P 50, I 100	102

Individual Element Performance

SNR is calculated for individual modes at the slice location. For the signal measurement, choose a ROI following the examples shown in *Figures 20, 21* and *22*.

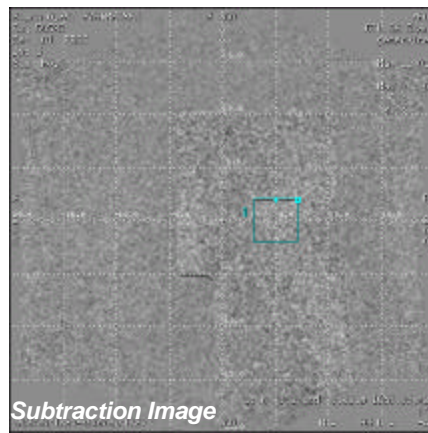
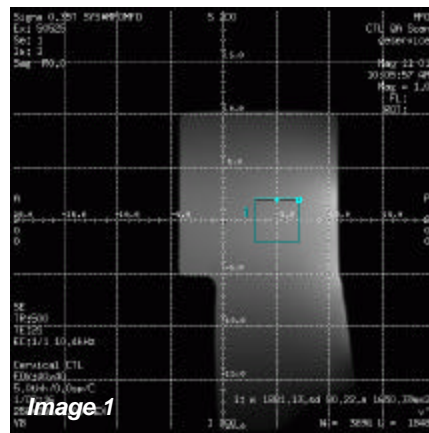

Figure 20: Cervical CTL images.

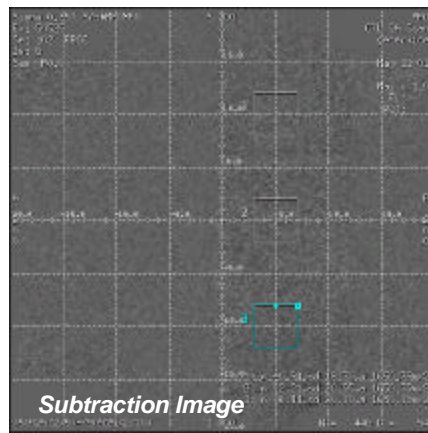
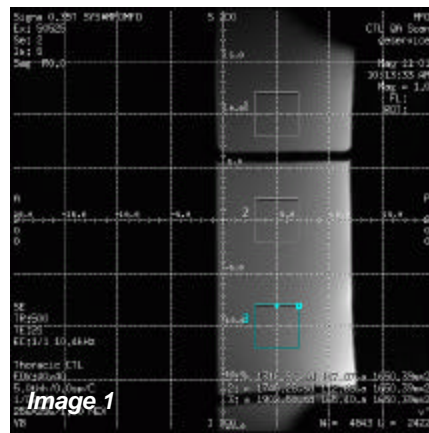

Figure 21: Thoracic CTL images.

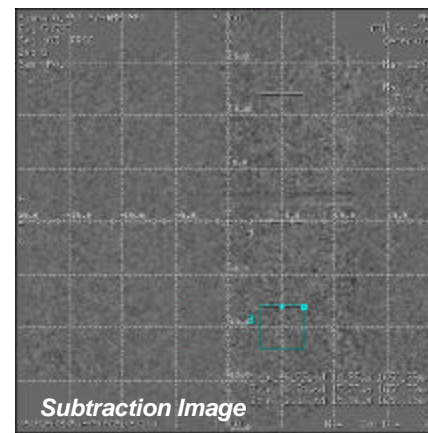
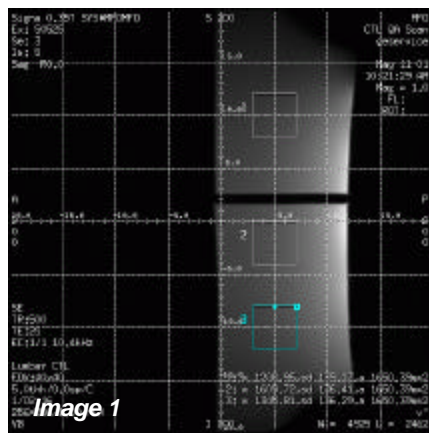

Figure 22: Lumbar CTL images.

3-2-7 SNR Check Method for MFO2 or Later Systems

1. Run the CTL SNR Tool:
 - a. Place the cursor in the C-shell.
 - b. Type “`cd /usr/g/bin`” and press **Return**.
 - c. Type “`mfoctl`” and press **Return**.

```
winterm
-----
{ } [ ] cd /usr/g/bin           return
{ } [ ] mfoctl                 return
```

Figure 23: CTL SNR Tool.

2. Enter the image information:
 - a. Type the first letter of the appropriate mode (for example: “c” if you are calculating SNR for C-mode) and press **Return**.
 - b. Enter the exam number, series number, and image number of the first image.
 - c. Enter the exam number, series number, and image number of the second image.
 - d. The Coil SNR Tool will display the SNR value.

```
winterm
-----
Select mode [C/T/L]: c           return
Enter exam for signal 1: 54211    return
Enter series for signal 1: 8      return
Enter image for signal 1: 1      return

You selected 54211/8/3 for signal 1.

Enter exam for signal 2: 54211    return
Enter series for signal 2: 8      return
Enter image for signal 2: 2      return

You selected 54211/8/6 for signal 2.

ROI (P50, S/I0): mean1 = 1095.10  mean2 = 1093.51  SD = 4.73  SNR = 327.347
```

Figure 24: Entering the image information.

3. Record the SNR value in the SNR worksheet.
4. Repeat Steps 2 and 3 for T-Spine and L-Spine images.

3-3 External Cable Check

Diode check from the connector:

Step 1 – Using a multi-meter set to the diode check function, check the coil diodes in the following manner.

Step 2 – Orient the connector as shown in *Figure 25*.

Step 3 – Follow External Cable Expected Readings – Table 3-3 for the correct pins and lead locations to verify the function of the diodes.

EXPECTED READINGS – TABLE 3-3

Signal	Positive Lead	Negative Lead	Reading
Diode Check (Ch1)	Conn Pin A3	Conn Pin B1	0.88-1.20
Diode Check (Ch2)	Conn Pin D2	Conn Pin B1	0.88-1.20
Diode Check (Ch3)	Conn Pin A5	Conn Pin B1	0.88-1.20
Diode Check (Ch4)	Conn Pin D4	Conn Pin B1	1.40-1.75
Diode Check (Ch5)	Conn Pin D12	Conn Pin B1	1.40-1.75
Diode Check (Ch6)	Conn Pin A11	Conn Pin B1	1.40-1.75
Diode Check (Ch7)	Conn Pin D14	Conn Pin B1	0.88-1.20

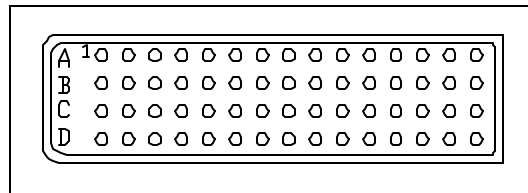

Figure 25: 60 pin Bendix connector.

3-4 PIN Diodes Check

Same as External Cable Check.

3-5 Mechanical Hardware Check

Check 1 – If one or two sides of the T/L belts do not spring up when the T/L belt release is turned, follow the steps below:

- Step 1 – Clean the female electrical connectors using the procedure outlined in Section 4 – Maintenance.
- Step 2 – Remove the T/L belts. Turn one of the T/L belt releases fully, and check each mechanical latch hole (two per side). If the hooks are regressing completely when the release is turned, repeat for the other side. If one side is regressing and the other is not, return the coil.

Check 2 – Check the T/L belts. If the T/L belts are cracked or warped, replace the coil.

Check 3 – Check the cervical bridge. If the cervical bridge is difficult to engage and disengage on the coil, replace the coil.

3-6 Troubleshooting Tips

Symptom #1: The system reports a coil fault during prescan or does not recognize the coil connection to the system when selected in the software.

Probable Cause	Suggested Actions	Resolution
The coil connector has become disconnected from the system interface.	Check to make sure the coil connector is fully engaged.	Engage connector and try the scan again. Make sure the indicator light on the patient table turns green with the proper coil selected on the console.
There is a DC short or open somewhere within the DC path inside the coil.	Check each channel using Expected Readings – Table 3-3. Check the coil and associated DC paths with a DVM, in both diode check and resistance modes.	If a short or open is observed, check the output cable by itself (see below). If the cable and PIN diodes are okay, then replace the coil.
The output cable has a short or an open.	Disconnect the cable at the coil and check each coaxial line with a DVM (resistance). Try moving and twisting the cable as you watch the meter to find any intermittent connections. Inspect the center pins of the SMB and Bendix connections for wear and proper engagement into the mating connection	Replace the coil.
There is a problem with the DC bias from the system interface or the coil ID circuitry.	Check to ensure the correct DC bias is being provided to the coil during transmit and receive per GEMS System Service Manual. Try a similar 2-channel coil to see if the same problem occurs	Correct MRI system problem.

Symptom #2: The coil does not pass SNR tests or exhibits poor image quality on patient scans.

Probable Cause	Suggested Actions	Resolution
One or more of the coil channels has a high noise level.	Look at the uncombined images to determine which channel has the problem. Compare the noise standard deviation measurements between channels and system performance logs; they should be approximately the same.	Replace the coil.
One or more of the coil channels has low signal.	Look at the uncombined images to determine which channel has the problem. Compare signal mean measurements between channels and system performance logs.	Replace the coil.
Excessive ghosting is causing the noise std. dev. measurements to be artificially high.	Window and level the images down to look at the background for signs of ghosting. Try padding the phantom in the holder. Try running the scan without the phantom holder to see if the ghosting diminishes.	Try a different coil. If padding or changing the phantom position can minimize ghosting, then the problem is caused by excessive vibration elsewhere in the system. If the ghosting is not symptomatic of phantom positioning or padding, then replace the coil.
There is a problem with the DC bias from the system interface or the coil ID circuitry.	Check to ensure the correct DC bias is being provided to the coils during transmit and receive per GEMS System Service Manual.	Correct MRI system DC bias problem.

3-7 Troubleshooting Strategy

When troubleshooting a suspect coil, a quick check for dead elements is best accomplished using a sagittal scan. Use the Scan Protocols – Table 3-2-3 for this purpose. Before the scan, follow the steps below to save the intermediate images.

1. Point the mouse to [**Research Operations**]. Then click the right mouse button.
2. Select [**Display CVs**].
3. Enter “saveinter” for CV name; set the current value to 1. Press the **Enter** key to save the changes made in the “saveinter” window. Press [**Accept**] to close the window.

The intermediate sagittal images produced using the Scan Protocols – Table 3-2-3 should show signal in each receiver (notice intermediate image #4 of both thoracic and lumbar show noise because these modes have three channel coils, not four; this #4 noise image is normal). The appearance of the images (brightness and shading) will correspond with the type and location of the individual coil elements. First display all the images for a particular section of the coil in the browser by clicking the user interface button **Format** and selecting a block of four. Next, touch the middle mouse button over an image in the series with good signal to make the window/level settings equal on all images. Verify that each element performs as expected using the Element-to-Receiver mapping diagram below. Example images of a CTL coil are shown in *Figures 26 through 40*. Use the Troubleshooting SNR Check Sheet in the Appendix to record the results and when communicating with service personnel.

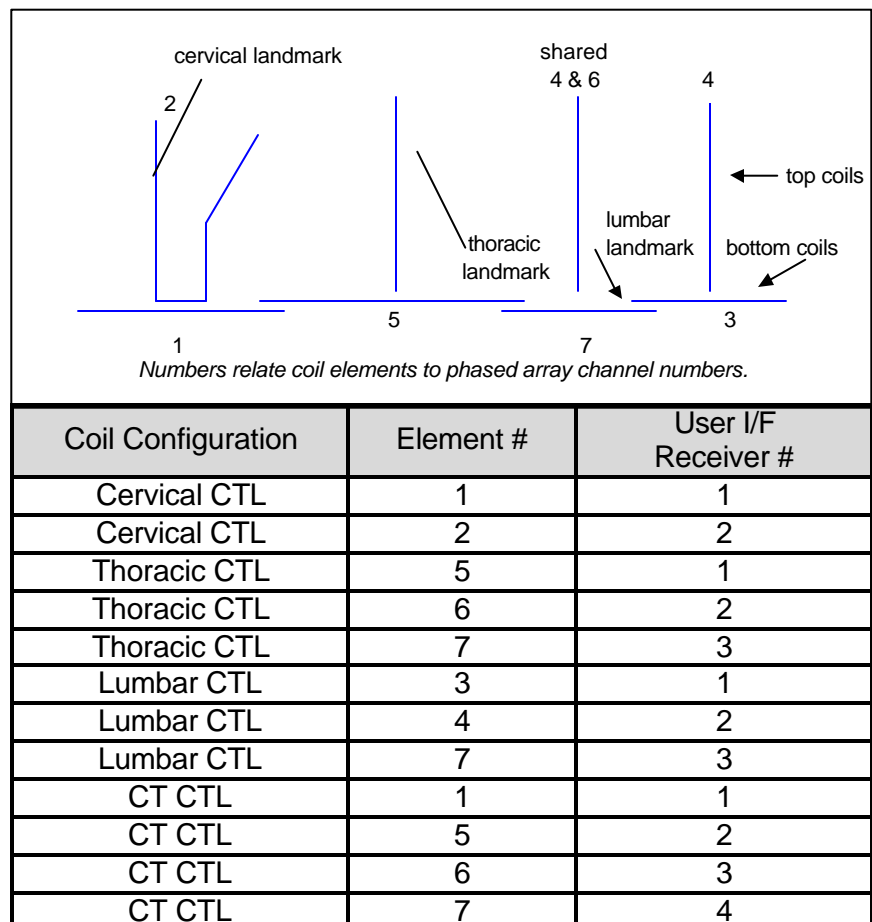

Coil Element Information

Cervical CTL

element name	cervical saddle	cervical loop	lumbar saddle	lumbar loop	thoracic saddle	thoracic loop	T&L saddle	not used
channel number	1	2	3	4	5	6	7	8
selected channel	yes	yes	no	no	no	no	no	no
mc bias driver #	1	1	2	2	3	3	4	4
active bias driver	yes	yes	no	no	no	no	no	no

Thoracic CTL

element name	cervical saddle	cervical loop	lumbar saddle	lumbar loop	thoracic saddle	thoracic loop	T&L saddle	not used
channel number	1	2	3	4	5	6	7	8
selected channel	no	no	no	no	yes	yes	yes	no
mc bias driver #	1	1	2	2	3	4	4	4
active bias driver	no	no	no	no	yes	yes	yes	yes

CT CTL

element name	cervical saddle	cervical loop	lumbar saddle	lumbar loop	thoracic saddle	thoracic loop	T&L saddle	not used
channel number	1	2	3	4	5	6	7	8
selected channel	yes	no	no	no	yes	yes	yes	no
mc bias driver #	1	1	2	2	3	3	4	4
active bias driver	yes	yes	no	no	yes	yes	yes	yes

Lumbar CTL

element name	cervical saddle	cervical loop	lumbar saddle	lumbar loop	thoracic saddle	thoracic loop	T&L saddle	not used
channel number	1	2	3	4	5	6	7	8
selected channel	no	no	yes	yes	no	no	yes	no
mc bias driver #	1	1	2	2	3	3	4	4
active bias driver	no	no	yes	yes	no	no	yes	yes

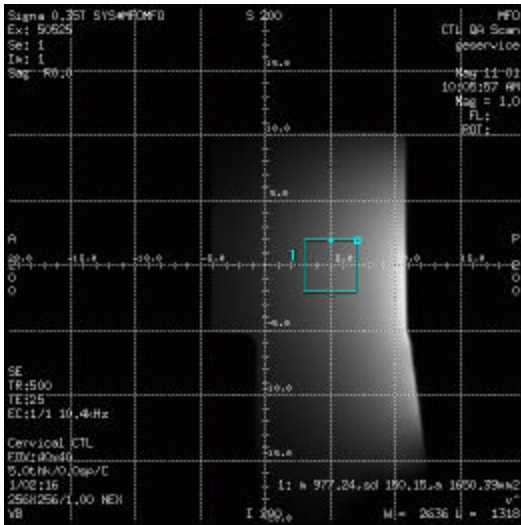

Figure 26: Cervical, Element #1
 (user I/F Rcvr #1).

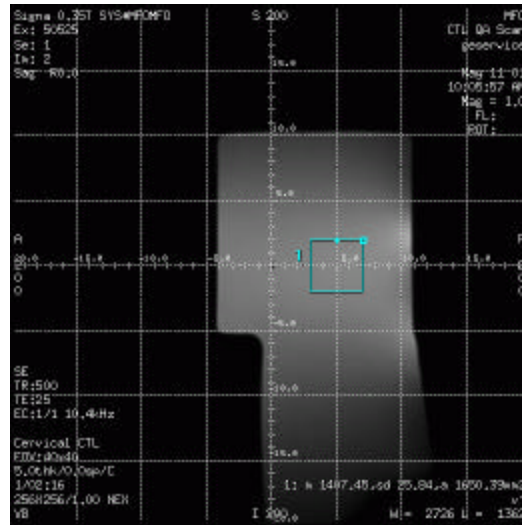

Figure 27: Cervical, Element #2
 (user I/F Rcvr #2).

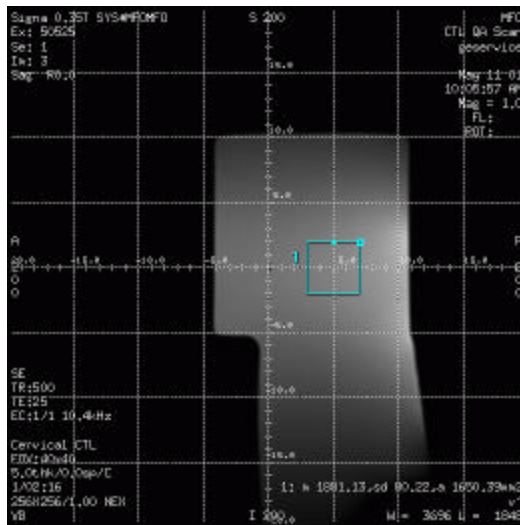

Figure 28: Cervical composite.

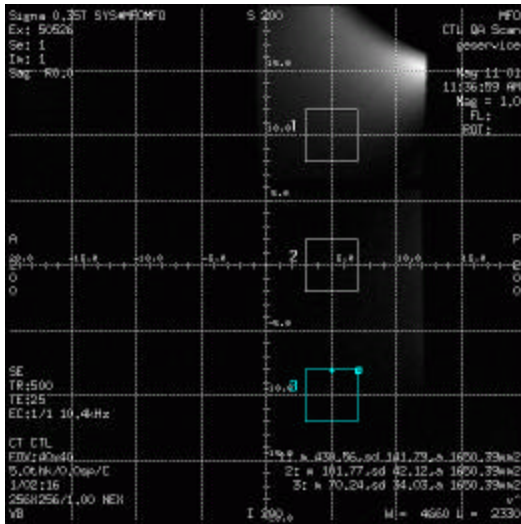

Figure 29: CT, Element #1
 (user I/F Rcvr #1).

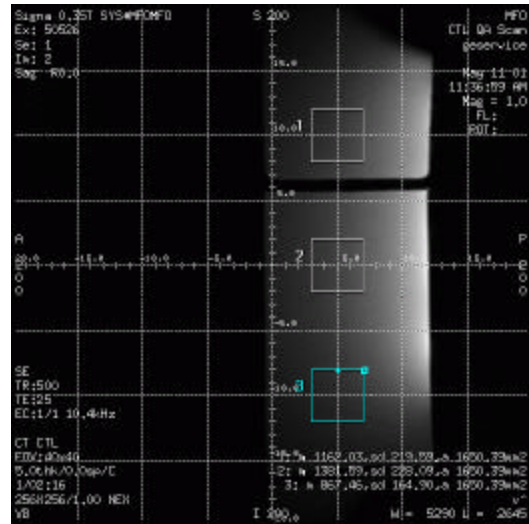

Figure 30: CT, Element #5
 (user I/F Rcvr #2).

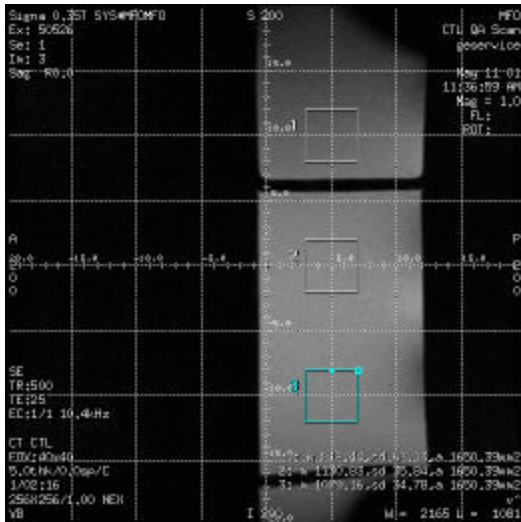

Figure 31: CT, Element #6
 (user I/F Rcvr #3).

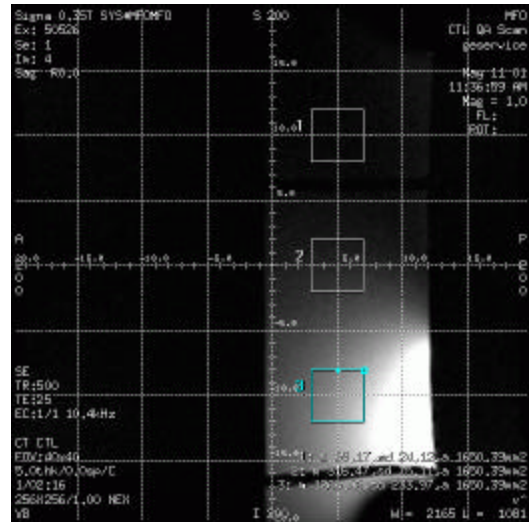

Figure 32: CT, Element #7
 (user I/F Rcvr #4).

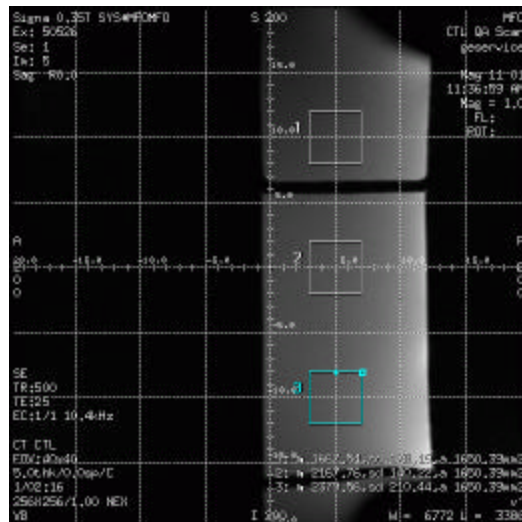

Figure 33: CT composite.

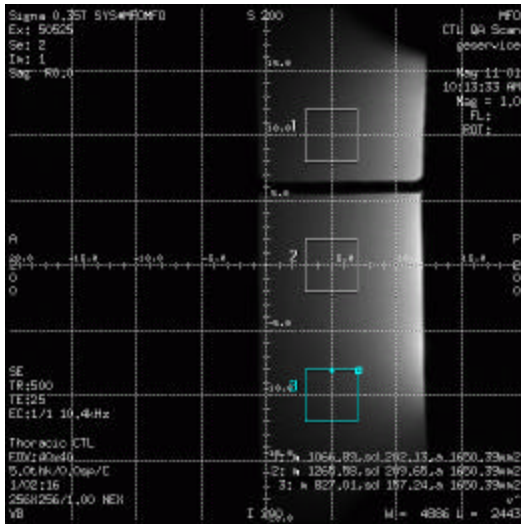

Figure 34: Thoracic, Element #5
(user I/F Rcvr #1).

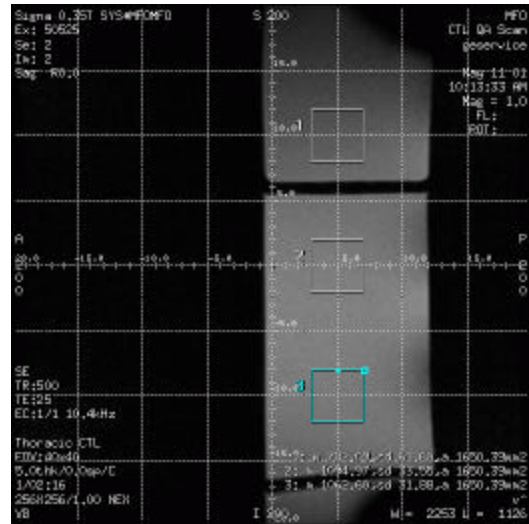

Figure 35: Thoracic, Element #6,
(user I/F Rcvr #2).

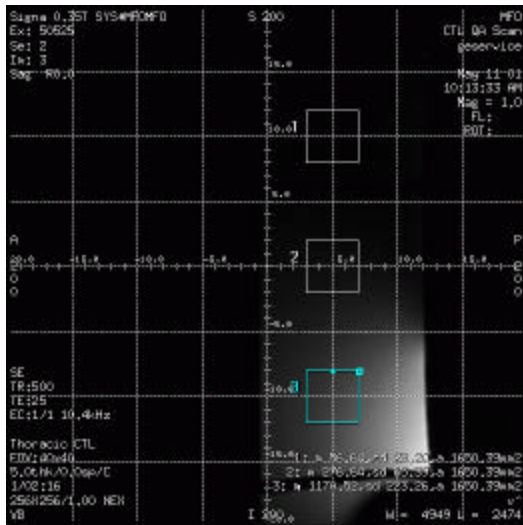

Figure 36: Thoracic, Element #7,
(user I/F Rcvr #3).

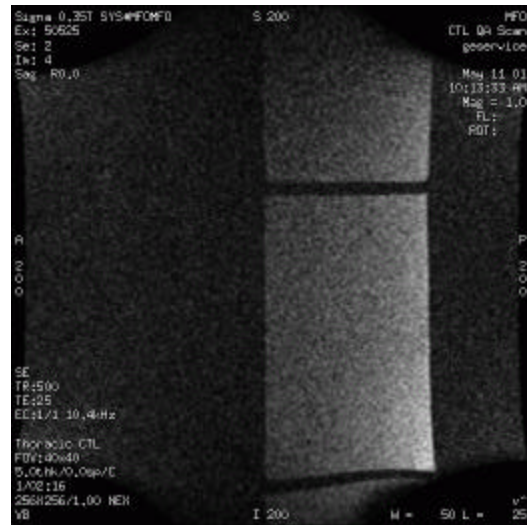

Figure 37: Thoracic, Element #xx,
(user I/F Rcvr #4).

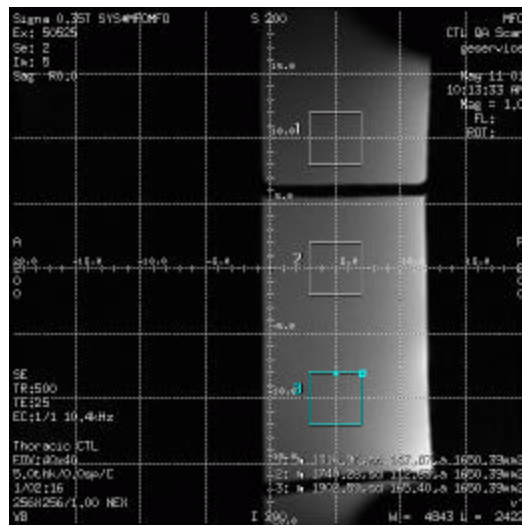

Figure 38: Thoracic composite.

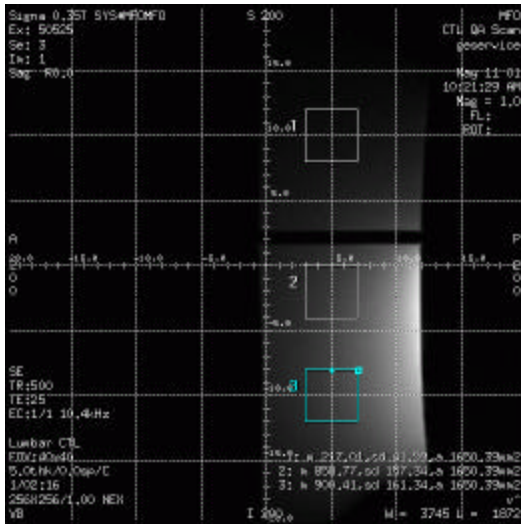

Figure 39: Lumbar, Element #3
(user I/F Rcvr #1).

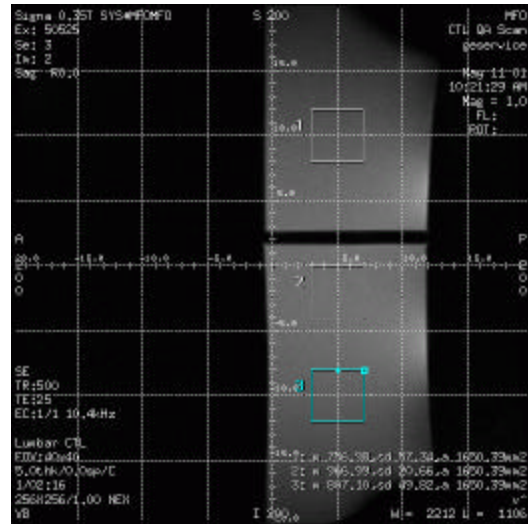

Figure 40: Lumbar, Element #4
(user I/F Rcvr #2).

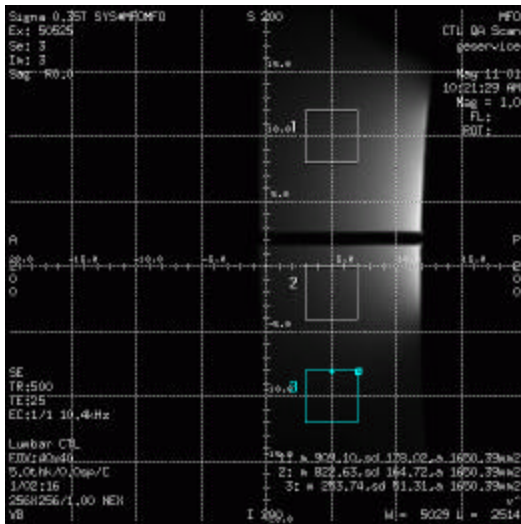

Figure 41: Lumbar, Element #7
(user I/F, Rcvr #3).



Figure 42: Lumbar, Element #XX
(user I/F Rcvr #4).

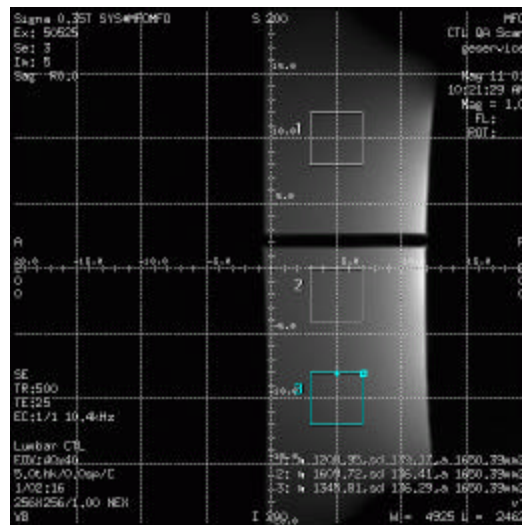

Figure 43: Lumbar composite.

SECTION 4 – MAINTENANCE

4-1 Coil Care



Detach the coil connector from the system before attempting to clean the coil. Do not reattach the connector after cleaning until the coil has dried completely. Electrical shock may result if the coil is attached to the system during cleaning or when it is wet.



Do not spray or pour cleaning solution directly on the coil. Do not submerge the coil in the solution. The coil contains sensitive electronics components that could be damaged by the solution.

The following solutions are recommended for the coil and pad surfaces: (1) a ten percent bleach solution (some discoloration may occur), (2) one ounce commercial dishwashing liquid mixed with one gallon of water or (3) warm water. Apply cleaning solution to a soft cotton cloth and proceed to clean. To prevent soiling of the coil, the user should place a cotton sheet over the coil before positioning the patient. If the coil is soiled, clean the coil as described above.

4-2 Special Care Requirements

Prior to returning a coil for service, use a ten percent bleach solution (as described above) to eliminate risk of exposure to potentially infectious materials.

SECTION 5 – REPLACEMENT

Simple removals that are clearly obvious are not described here.

Unless otherwise noted, the steps for re-assembly are simply the reverse order of the steps described for disassembly.

5-1 External Cable Replacement

Step 1 – Remove coil cover.

Step 2 – Remove the four screws that hold down the cable assembly.

Step 3 – Disconnect SMB plugs on the cable end from the interface boards.

Step 4 – Remove the old cable assembly.

Step 5 – Fix a new cable assembly on the CTL coil and reattach the cable lock with four screws. Connect all eight SMB plugs to the corresponding receptacles on the interface board.

Step 6 – Close the coil cover.

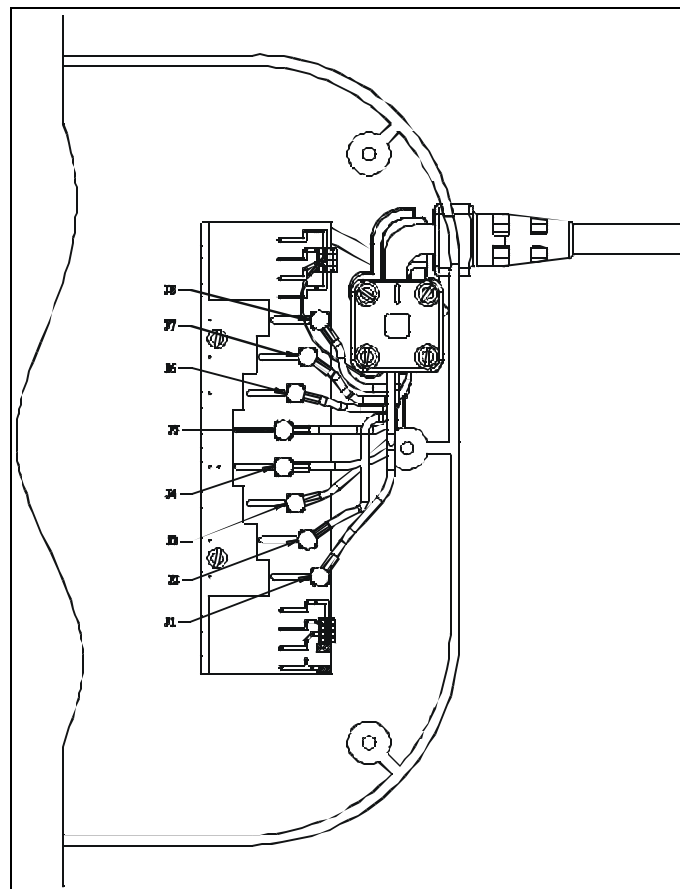

Figure 44: Cable assembly.

SECTION 6 – RENEWAL PARTS

6-1 Field Replaceable Units

FIELD REPLACEABLE UNITS – TABLE 6-1

Part Name	GE Part #	USAI Part #
Coil	2282860	100216
Cable Assembly with QD Box	2284645	110163
CT Phantom	2264744-7	150161
TL Phantom	2264744-8	150162
Service Tuning Cable Set	2284647	150239

6-2 Other Replaceable Accessories

OTHER REPLACEABLE ACCESSORIES – TABLE 6-2

Part Name	GE Part #	USAI Part #
Patient Comfort Pad	2284651	150213
Neck Support Pad	E8801TK	150170

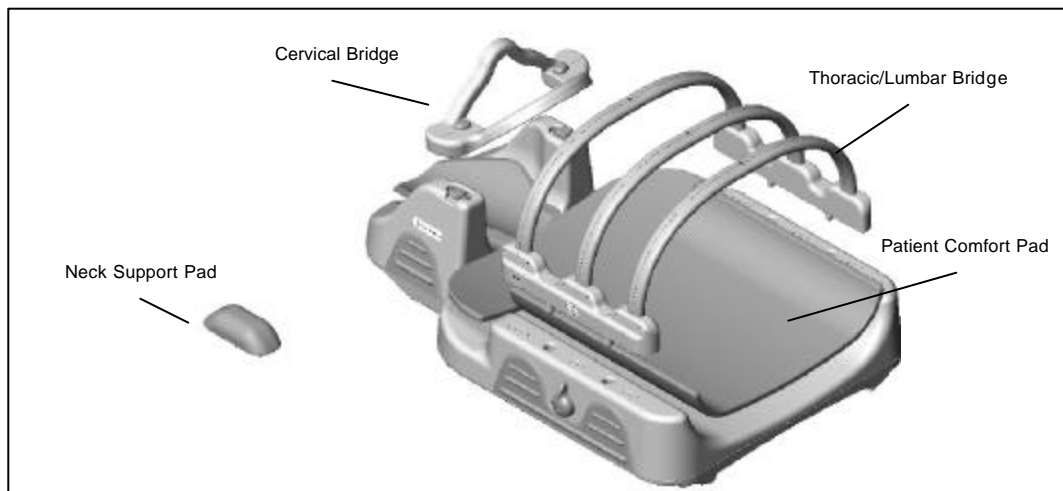

Figure 45: Parts of the coil.

SECTION 7 – APPENDIX

7-1 SNR Data Sheet

Use the table provided below to record the calculated signal to noise ratio (SNR) data obtained from the Functional Checks section.

Date Tested	Configuration	ROI Position	Signal Mean 1 (Image 1)	Signal Mean 2 (Image 2)	Noise SD from Subtraction Image	SNR	Spec
	Cervical	P 50, S/I 0					≥ 269
	R1 =		R2 =				
	TG =		Freq =				
	Thoracic	P 50, S 100					≥ 89
	Thoracic	P 50, S/I 0					≥ 104
	Thoracic	P 50, I 100					≥ 118
	R1 =		R2 =				
	TG =		Freq =				
	Lumbar	P 50, S 100					≥ 105
	Lumbar	P 50, I 20					≥ 114
	Lumbar	P 50, I 100					≥ 102
	R1 =		R2 =				
	TG =		Freq =				

Date Tested	Configuration	ROI Position	Signal Mean 1 (Image 1)	Signal Mean 2 (Image 2)	Noise SD from Subtraction Image	SNR	Spec
	Cervical	P 50, S/I 0					≥ 269
	R1 =		R2 =				
	TG =		Freq =				
	Thoracic	P 50, S 100					≥ 89
	Thoracic	P 50, S/I 0					≥ 104
	Thoracic	P 50, I 100					≥ 118
	R1 =		R2 =				
	TG =		Freq =				
	Lumbar	P 50, S 100					≥ 105
	Lumbar	P 50, I 20					≥ 114
	Lumbar	P 50, I 100					≥ 102
	R1 =		R2 =				
	TG =		Freq =				

7-2 Troubleshooting SNR Check Sheet

Use the table provided below to record the results of the Troubleshooting sagittal scan.

Date Tested	Configuration	Element	Image #	ROI Position	Signal Mean 1	Signal Mean 2	Noise SD from Subtraction Image	SNR
	Cervical	1	1	P 50, S/I 0				
	Cervical	2	2	P 50, S/I 0				
	Cervical	Composite	3	P 50, S/I 0				
		R1=		R2=				
		TG =		Freq=				

Remove the cervical bridge only for CT mode scan.

CT	1	1	P 50, S 100				
CT	1	1	P 50, S/I 0				
CT	1	1	P 50, I 100				
CT	5	2	P 50, S 100				
CT	5	2	P 50, S/I 0	-	-	-	-
CT	5	2	P 50, I 100	-	-	-	-
CT	6	3	P 50, S 100				
CT	6	3	P 50, S/I 0				
CT	6	3	P 50, I 100				
CT	7	4	P 50, S 100	-	-	-	-
CT	7	4	P 50, S/I 0				
CT	7	4	P 50, I 100				
CT	Composite	5	P 50, S 100				
CT	Composite	5	P 50, S/I 0				
CT	Composite	5	P 50, I 100				
		R1=		R2=			
		TG=		Freq=			

Lumbar	3	1	P 50, S 100	-	-	-	-
Lumbar	3	1	P 50, I 20				
Lumbar	3	1	P 50, I 100				
Lumbar	4	2	P 50, S 100				
Lumbar	4	2	P 50, I 20				
Lumbar	4	2	P 50, I 100				
Lumbar	7	3	P 50, S 100				
Lumbar	7	3	P 50, I 20				
Lumbar	7	3	P 50, I 100	-	-	-	-
Lumbar	None	4	-	-	-	-	-
Lumbar	Composite	5	P 50, S 100				
Lumbar	Composite	5	P 50, I 20				
Lumbar	Composite	5	P 50, I 100				
		R1=		R2=			
		TG=		Freq=			

7-3 Schematic

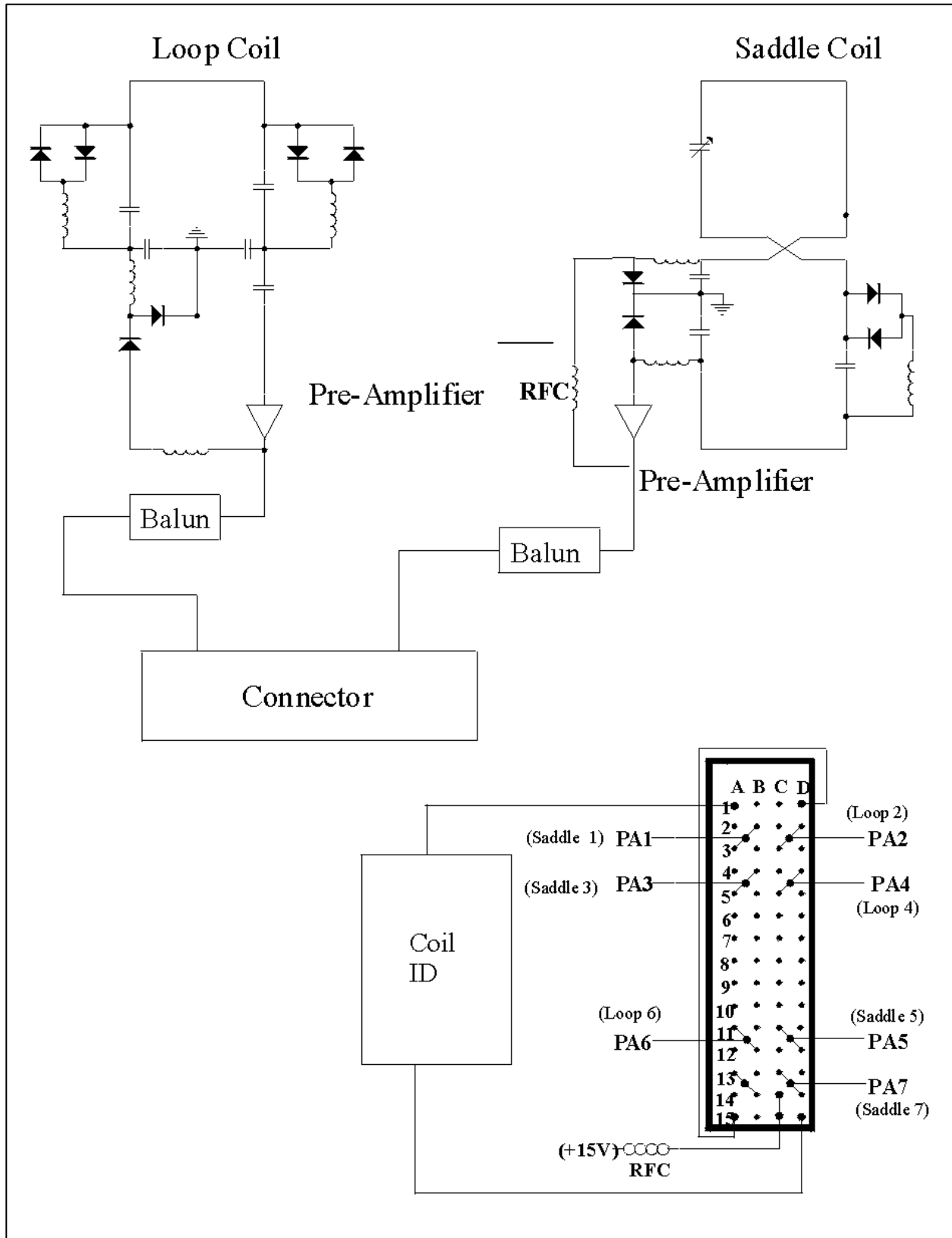

7-4 Configuration

Coil Name	Cervical CTL	Thoracic CTL	Lumbar CTL	CT CTL
Coil Code	CTL	CTL	CTL	CTL
Coil Type	3	3	3	3
Extremity Coil	no	no	no	no
Cable Loss	1	1	1	1
Coil Loss	1.165	1.165	1.165	1.165
Recon Scale Factor	0.9	2.9	2.6	3.1
Linear vs. Quadrature	1	1	1	1
Multiple Receiver Coil	yes	yes	yes	yes
Number of Receivers	2	4	4	4
Starting Receiver ID	0	0	0	0
Ending Receiver ID	1	3	3	3
Multi-Coil Port Enable	1	12	10	13
Multi-Coil Port Error Enable	1	12	10	13
Additional Transmit Attenuation	0	0	0	0
Number of Fast Receivers	0	0	0	0
Starting Fast Receiver ID	4	4	4	4
Ending Fast Receiver ID	4	4	4	4
Fast TG Start TA	90	90	90	90
Fast TG Start RG	12	12	12	12
Multi Coil Recon Enable	0	8	8	0
Multi Coil Channel Selection	3	112	76	113
Attenuation-Q	0	0	0	0
Attenuation-I	0	0	0	0
Select Quadrature Shifter	0	0	0	0
Phased Array T/R Coil for Autoshim	-1	-1	-1	-1
Head Default Freq Dir	0	0	0	0
quadRcvCoil	0	0	0	0
cfoption	0	0	0	0

REVISION HISTORY

Rev	Date	Author	Primary Reason for Change
A	04/30/01	Reva Zaretsky	First Issue
B	10/01/01	Reva Zaretsky	Revised Configuration Table
C	12/01/01	Reva Zaretsky	Revised Configuration Table
D	02/28/02	Linda Foust	Revised Field Replaceable Units Table
E	05/01/02	Teresa DeMarco	Revised Sections 3-2-5, 3-2-6 and 3-2-7
F	07/01/02	Teresa DeMarco	Revised SNR Specifications, SNR Data Sheet and Troubleshooting SNR Check Sheet